

prio silent 150EC duct fan

Номер позиции: 39484

Вариант: 230В 1~ 50/60Гц



EC-motors, high level of efficiency

Low SFP values

100% speed controllable

Integrated motor protection

Can be installed in any position

Compact design

Acoustic foam for low noise level

Potentiometer included for ease of commissioning

EC fans are intelligent devices using integrated motor electronics, ensuring that the motor always runs at optimal load. With EC motors the proportion of energy utilized effectively is higher, which as a result reduces the energy usage considerably, compared with AC motors.

Another special feature of EC fans is their energy-saving potential not only at full load, but especially when speed controlled, i.e. at part load. When operating at part-load, the energy used is much lower than with an asynchronous motor of equivalent output. Reduced energy usage guarantees a drop in operating costs.

The prio silent series is designed for installation in ducts. Prio silent fans have spigot connections with double lip seal made of EPDM-rubber in according with EN 1506:1997

The fans have aerodynamically optimized impellers and guide vanes. Motor protection is integrated in the electronics of the motor. The acoustic foam is specially designed to absorb noise without restricting the air flow.

The mounting clamp facilitates easy installation and removal, and prevents the transfer of vibrations to the duct. For installation the prio silent have pre-mounted hanging loops.

For installation in damp locations we recommend to use a run-on timer. The fans are delivered with a pre-wired potentiometer (0-10V) that allows you to easily find the required working point.



Технические характеристики

Номинальные данные		
Напряжение (номинальное)	230	В
Частота	50; 60	Гц
Количество фаз	1~	
Потребляемая мощность	81	Вт
Потребляемый ток	0,684	А
Скорость вращения рабочего колеса	4 189	об/мин
Расход воздуха	макс. 767	д
Температура перемещаемого воздуха	макс. 55	°С
Макс. температура перемещаемого воздуха, при регулировании скорости	55	°С
Параметры звука		
Уровень звукового давления на 3 м (20м², сэбин)	38	дБ(А)
Защита / Классификация		
Класс защиты, двигатель	IP44	
Класс изоляции	В	
Размеры и вес		
Вес	5,6	кг
Другие		
Тип двигателя	ЕС	

Кривая производительности

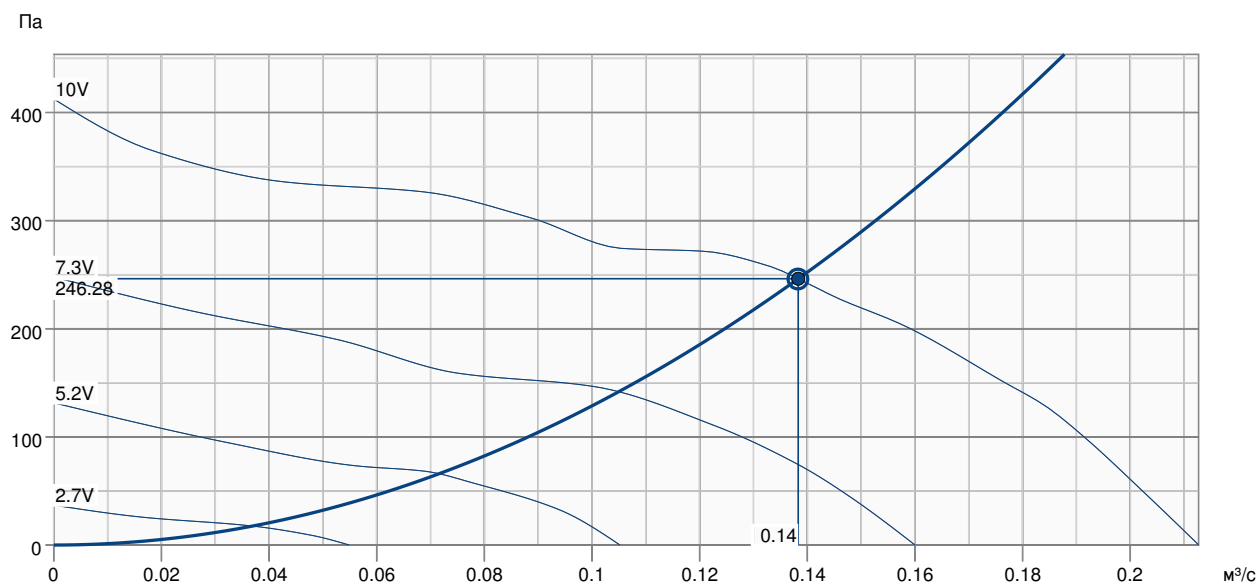

Данные по гидравлике

Требуемый расход воздуха	0.14 м³/с
Требуемое статическое давление	246.00 Па
Рабочий расход воздуха	0.14 м³/с
Рабочее статическое давление	246.28 Па
Плотность воздуха	1.20 kg/m³
Мощность	75.40 W
Регулирование скорости вентилятора - Об/мин	71.40 Hz
Ток	0.64 A
Удельная мощность вентилятора	0.55 кВт/м³/с
Напряжение прибора управления	10.00 V
Напряжение питания	230.00 V

Уровень звуковой мощности		63	125	250	500	1k	2k	4k	8k	Сумма
Входной	dB(A)	50	57	65	58	57	53	54	53	68
Выходящий	dB(A)	52	46	65	68	58	50	53	42	70
Окружение	dB(A)	41	38	39	35	43	36	32	30	48

Размер

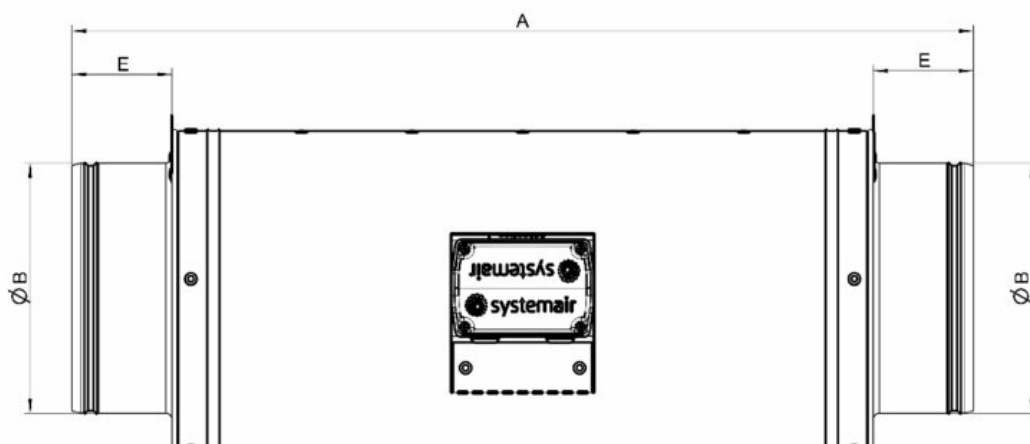
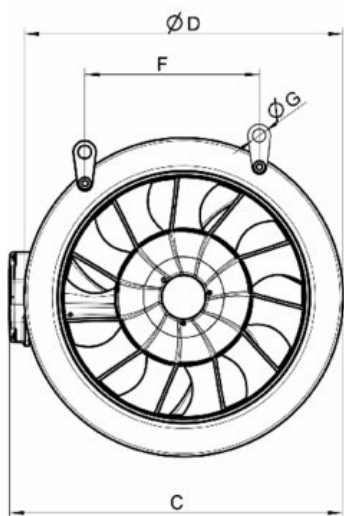

prio silent	A	$\varnothing B$	C	$\varnothing D$	E	F	$\varnothing G$
150	708	150	234	226	74	140	10,5

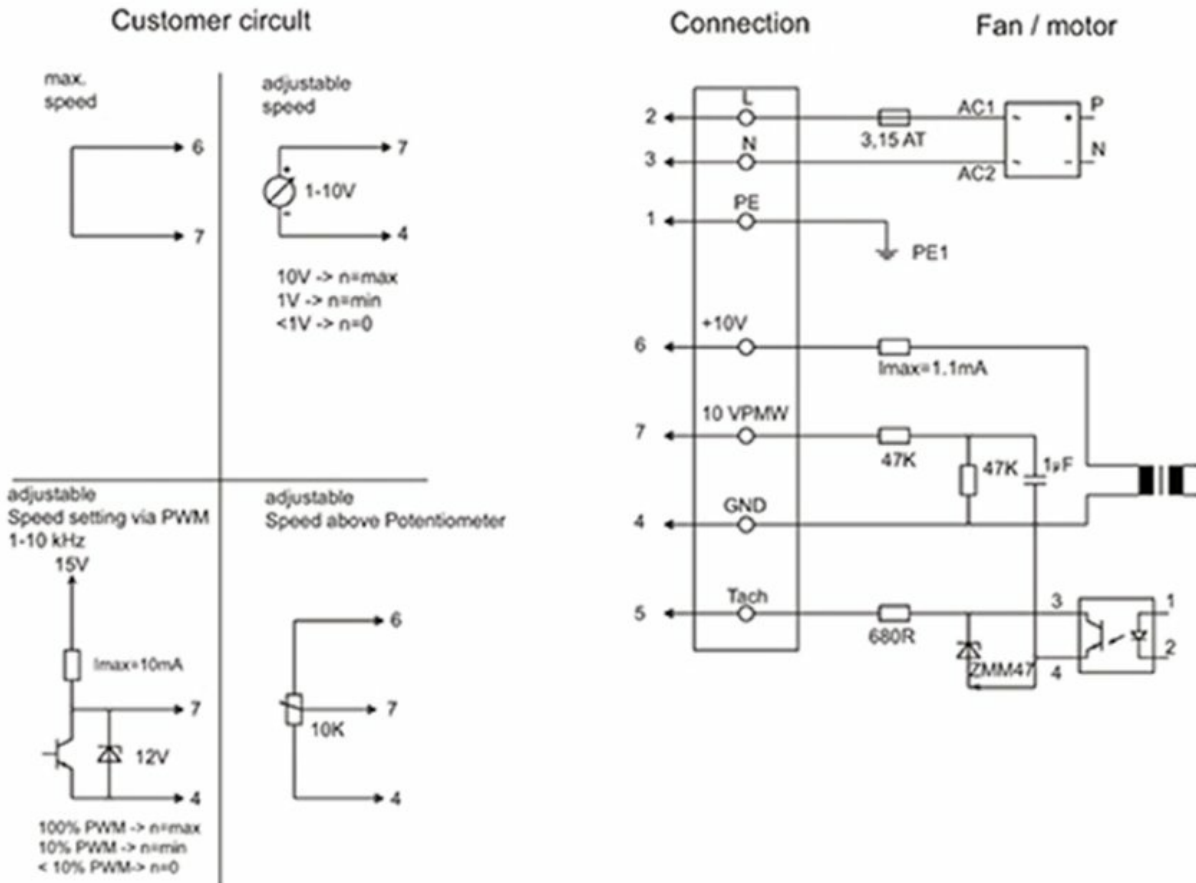

Line	No.	Signal	Colour	Function / assignment
	2	L	brown	Power supply 230 VAC, 50-60 Hz, see type plate for voltage range
	3	N	blue	Neutral conductor
	1	PE	green/yellow	Protective earth
	7	0-10V PWM	yellow	Control input 0 - 10 V or PWM, electrically isolated
	5	Tacho	white	Tach output: open collector, 1 pulse per revolution, electrically isolated, Isink_max=10mA
	6	10V/ max 1.1mA	red	Voltage output 10 V/ 1.1 mA, electrically isolated
	4	GND	blue	GND - Connection for control interface