

# 1KVT6 13/9 - DIESEL AND ELECTRIC EN 12845 FIRE-FIGHTING PUMP SETS WITH VERTICAL TURBINE PUMPS

Pumped liquid temperature range: from 0 °C to +40 °C - Ambient temperature range: from +4 °C to +40 °C

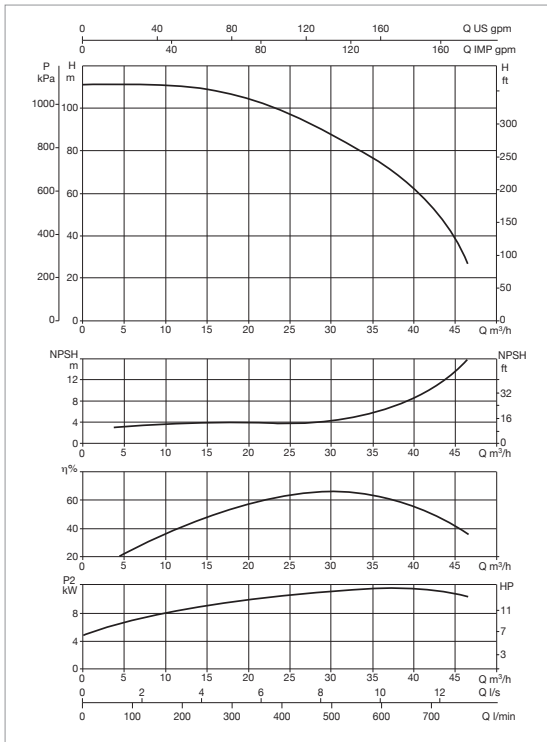

## KVT EN 12845 ELECTRIC PUMP

MODEL	POWER INPUT	JOCKEY PUMP*	P2 MAIN PUMP	P2 JOCKEY PUMP	In A	MEASURING KIT
			kW	kW		
1KVT6 13/9 15 400/50	3 x 400 V	DIVER 200 T	15	1.5	26.5	FLOW METER DN80

## KVT EN 12845 DIESEL ENGINE-DRIVEN PUMP

MODEL	BATTERY CHARGER POWER INPUT	JOCKEY PUMP*	** P2 DIESEL ENGINE-DRIVEN PUMP	P2 JOCKEY PUMP	AREA FAN	DIESEL COLLECTION TANK
			kW	kW		
1KVT6 13/9 15 MD	1 x 220-240 V	DIVER 200 T	15	1.5	0.22 m²	50 l included

\* Jockey pump on request.

\*\* ISO 3046 continuous power The motor is capable of delivering 10 % more of the power requested by the pump.

The performance curves are based on kinematic viscosity values = 1 mm²/s and density equal to 1000 kg/m³. Curve tolerance according to ISO 9906.

## ELECTRIC PUMP + DIESEL ENGINE-DRIVEN PUMP + JOCKEY PUMP MODULE

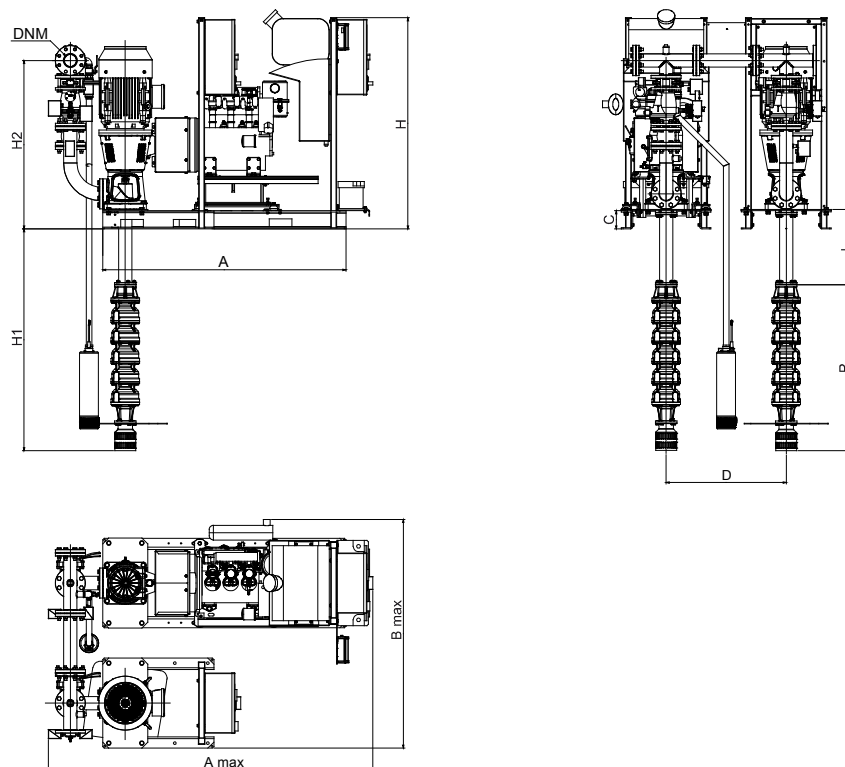

# 1KVT6 13/9 - DIESEL AND ELECTRIC EN 12845 FIRE-FIGHTING PUMP SETS WITH VERTICAL TURBINE PUMPS

## ELECTRIC PUMP MODULE

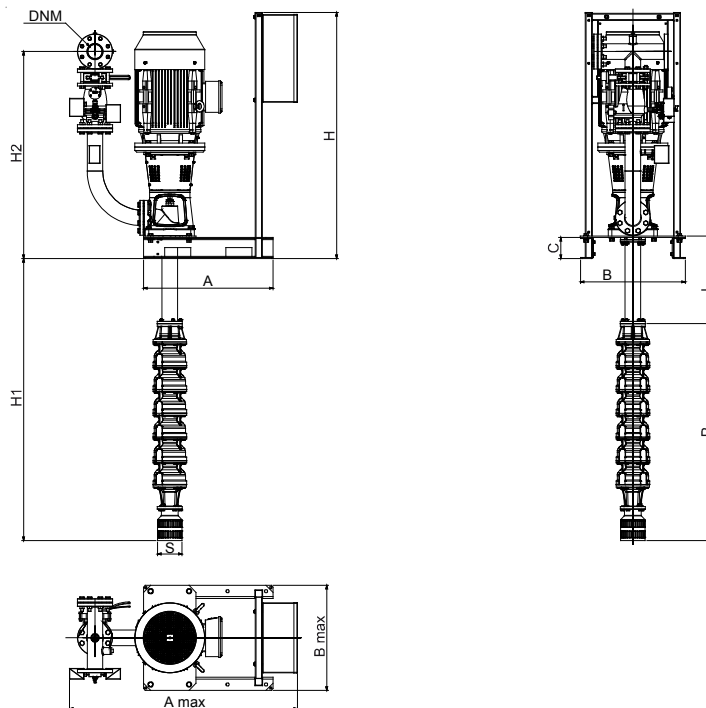

## DIESEL ENGINE-DRIVEN PUMP MODULE

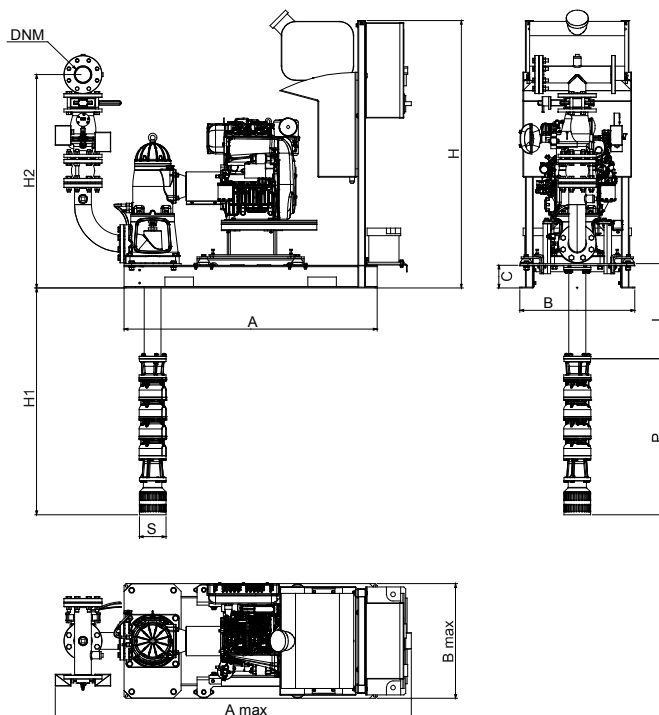

MODEL	A	A max	B	B max	C	H	H2	P	S	L	H1	A1	B1	H3	DNM
1KVT6 13/9 - ELECTRIC PUMP + DIESEL ENGINE-DRIVEN PUMP + JOCKEY PUMP MODULE	1330	1872	1602	120	1406	1183	1332	2000	3212						80
1KVT6 13/9 15 400/50 - ELECTRIC PUMP MODULE	740	1334	599	599	120	1406	1183	1332	Ø 140	2000	3212				80
1KVT6 13/9 15 MD - DIESEL ENGINE-DRIVEN PUMP MODULE	1330	1872	603	603	120	1406	1121	1332	Ø 140	2000	3212	-	-	-	80

The L and H1 values depend on the selected axis line (L).  
7 different axis line lengths available on request.