

NCE HQ.F Energy saving circulating pumps with flanges



Construction

Energy saving variable speed circulating pump driven by a permanent magnet synchronous motor (pm) controlled by on board inverter.

Digital input and output:

- remote on/off input
- output relay

Applications

Heating and conditioning systems.

Operating conditions

- Liquid temperature from +2 °C to +110 °C
- Ambient temperature from 0 °C to +40 °C
- Maximum permissible working pressure: 10 bar
- Storage: -20°C/+70°C max. relative humidity 95% at 40 °C
- Certifications: in conformity with CE requirements
- Sound pressure \leq 40 dB (A).
- Minimum suction pressure: - 0,05 bar at 75 °C
- 0,28 bar a 90 °C.
- Maximum glycol quantity: 20%.
- EMC according to: EN 55014-1, EN 55014-2
EN 61000-3-2, EN 61000-3-2.
- Connections: Flanges according to PN 6/10, EN 1092-2, DN 32,40,50,65,80,100.
- The benchmark for most efficient circulators is $EEL \leq 0,20$.

Designation

NCE HQ 40 F - 120 / 250

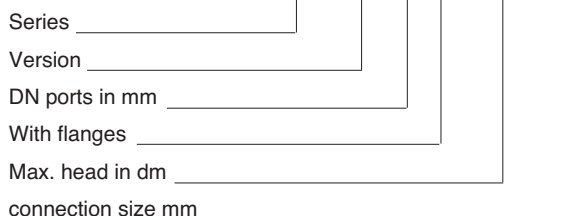

Motor

Synchronous motor with permanent magnet.

- Motor: variable speed
- Standard voltage: single-phase 230 V (-10%;+6%)
- Frequency: 50/60 Hz
- Protection: IP 44
- Insulation class: F
- Overload protection (integrated).
- Cable: phases and neutral.
- Constructed in accordance with: EN 60335-1, EN 60335-2-51.

Special features on request

Additional module:

- Modbus
- Ethernet
- analog input 0-10V

Features

Smart pump

NCE HQ.F adapt its functions to the system: the circulator measures the pressure and the flow and adjusts the speed to the selected pressure.

Easy use

There are different operating modes selectable from the control panel.

Operating modes



Automatic mode

(factory setting):

In this mode the pump automatically sets the operating pressure, depending on the hydraulic system. This mode is recommended in most systems.



Proportional pressure mode:

The circulator changes the pressure proportionally to the current flow. The pressure value can be adjusted with the + and - buttons.



Constant pressure mode:

The circulator maintains the pressure constant when the reference flow changes. The pressure value can be adjusted with the + and - buttons.



Fixed speed mode:

The circulator works with constant curve and the curve could be changed using + e - buttons.



Night mode:

When the liquid temperature fall by 15-20°C the pump automatically swiches to night mode, in practice the circulator works at minimum curve. When the temperature rises again the pump comes back to the selected mode. The night mode could be selected with any operating mode.

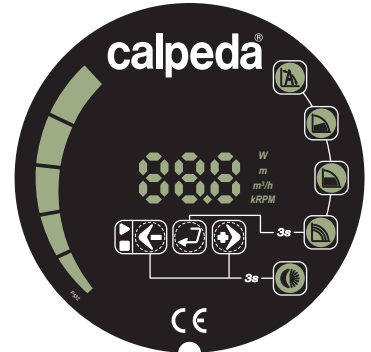

Operating mode-control panel

NCE HQ.F could works in:

- automatic mode
- proportional pressure mode
- constant pressure mode
- fixed speed mode
- night mode

The night mode could be selected with any operating mode.

Coverage chart

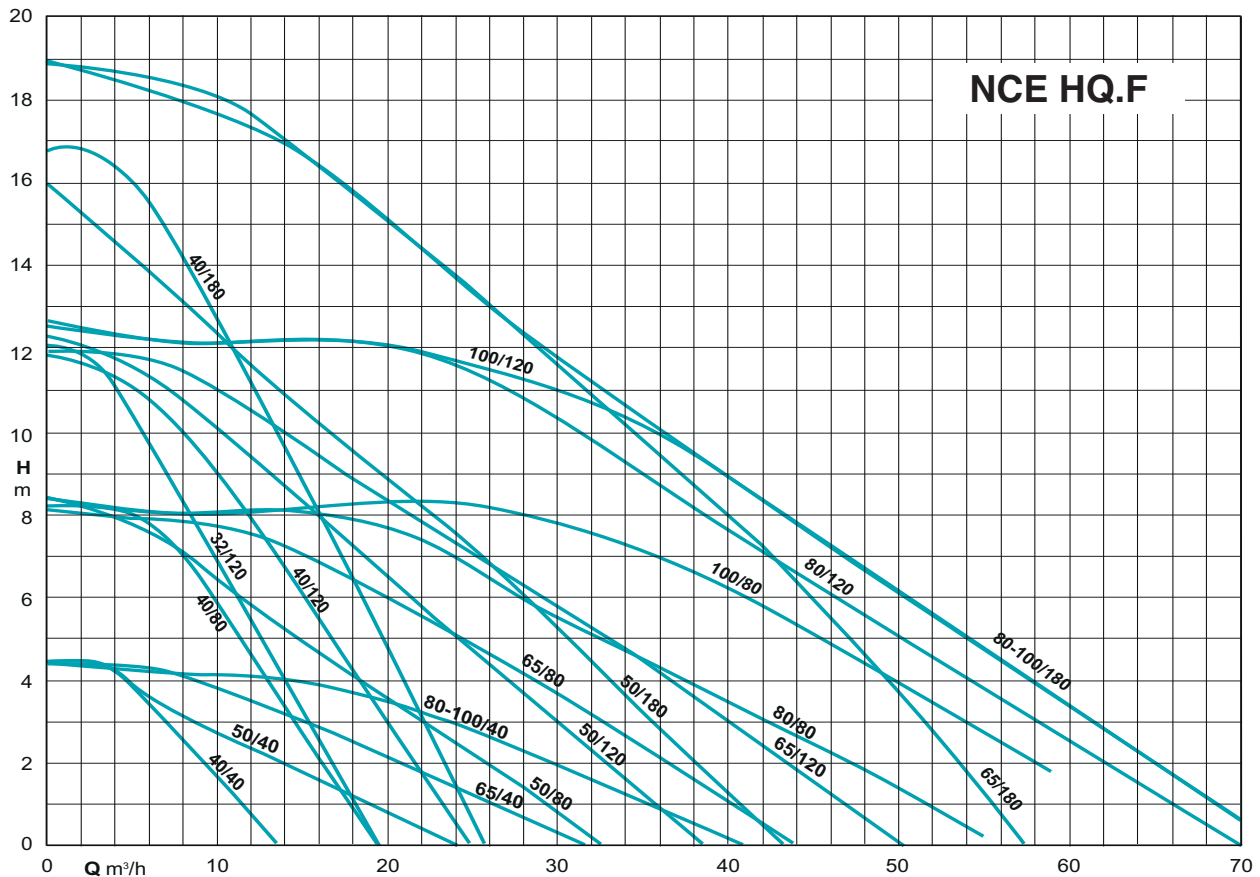

Materials

Component	Pos.	Material
Pump casing	1	Cast iron GJL 200 EN 1561
Impeller	2	Composite
Shaft	3	Stainless steel
Bearings	4	Carbon
Thrust bearing	5	Ceramic
Rotor	6	Stainless steel jacket
Winding	7	Copper wire
Electronic card	8	-
Gasket	9	EPDM

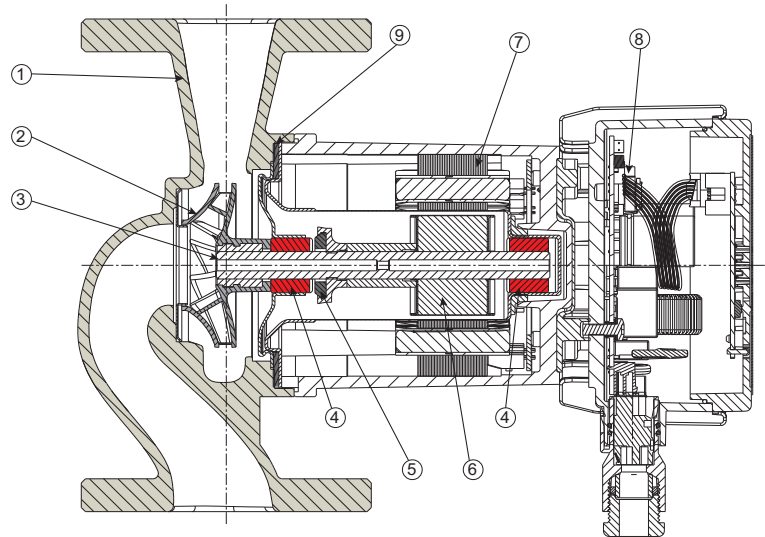

Characteristic curves

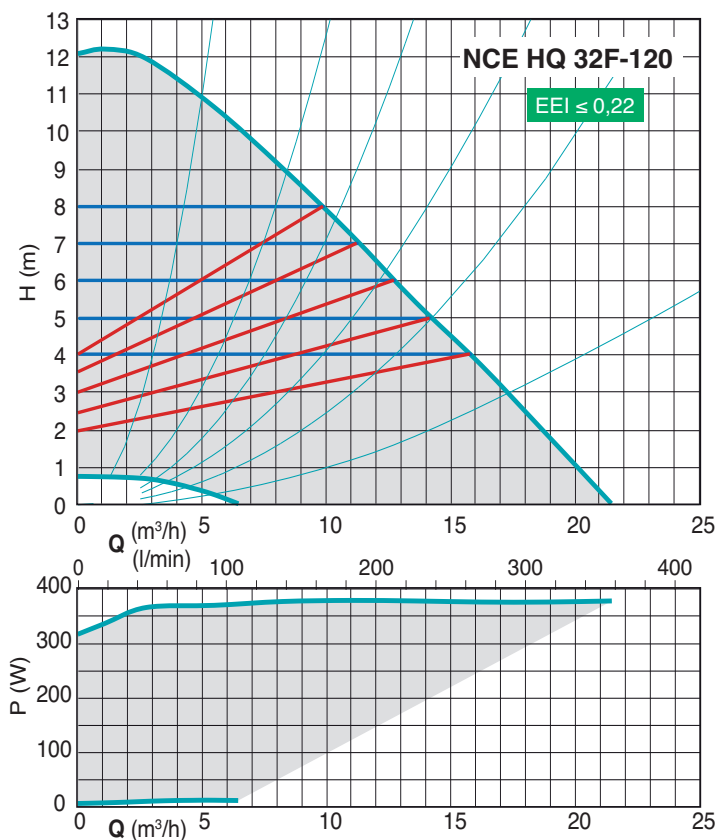

Characteristic curves

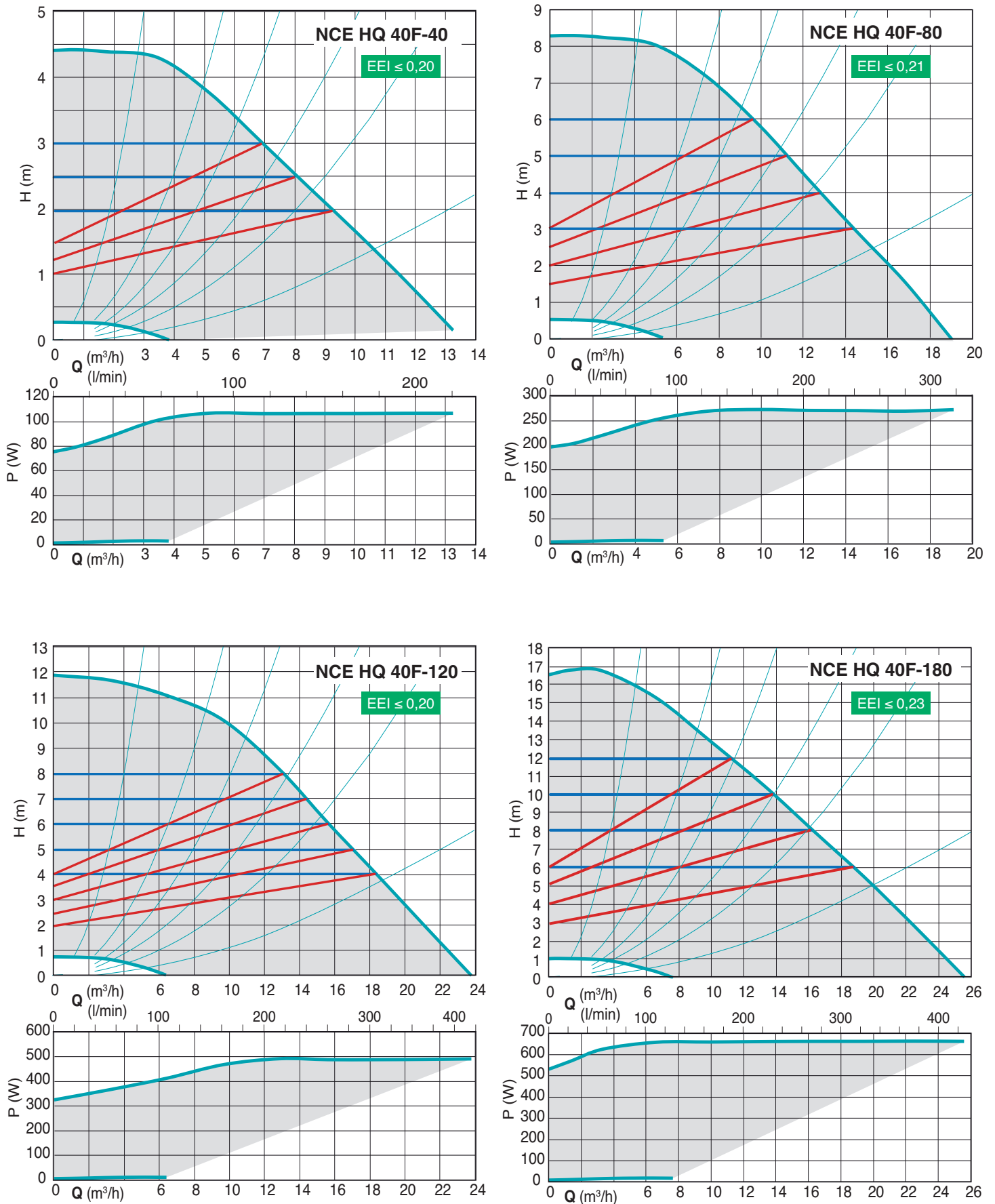

Characteristic curves

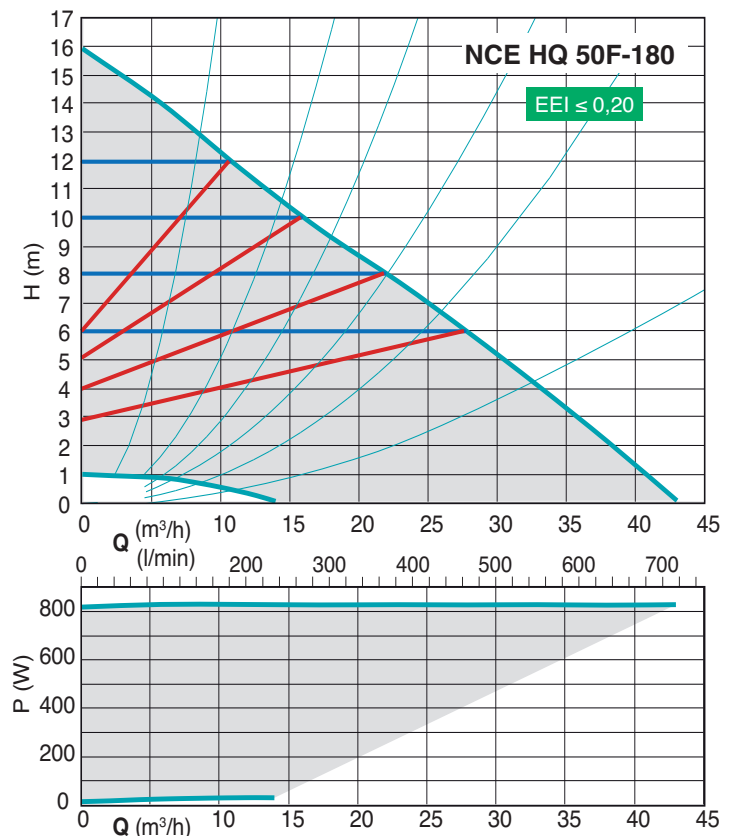
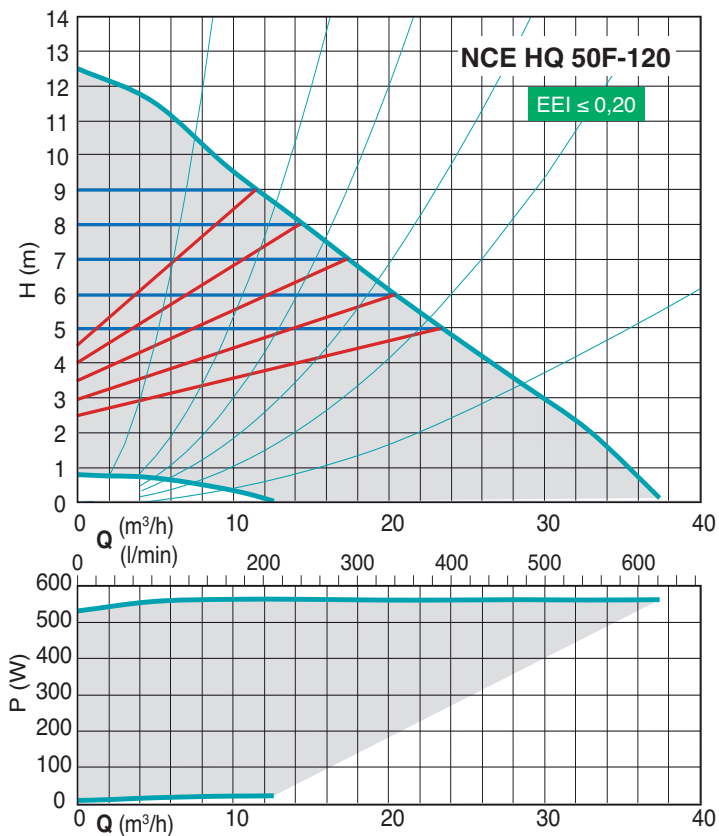
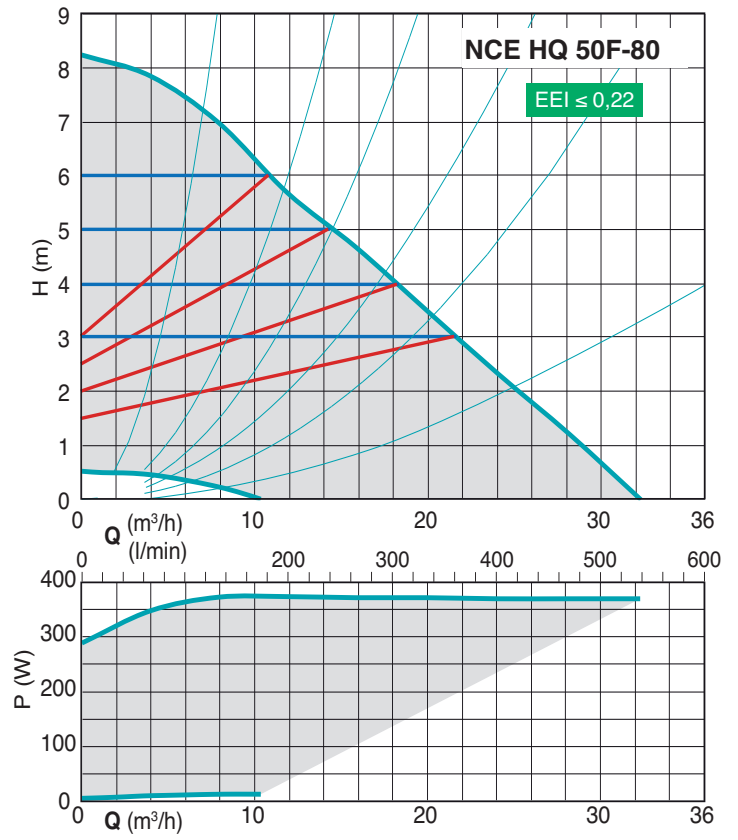
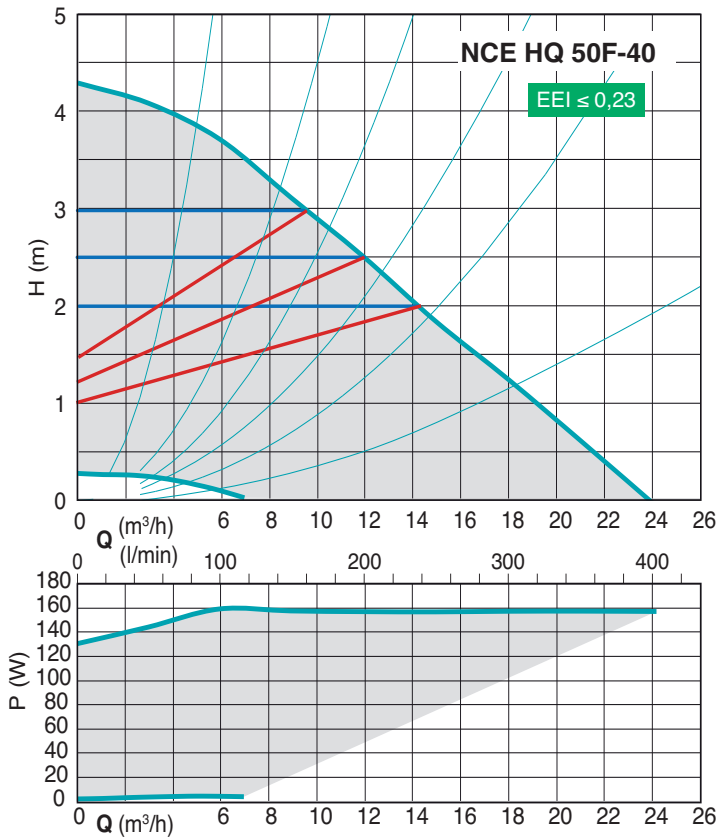

Characteristic curves

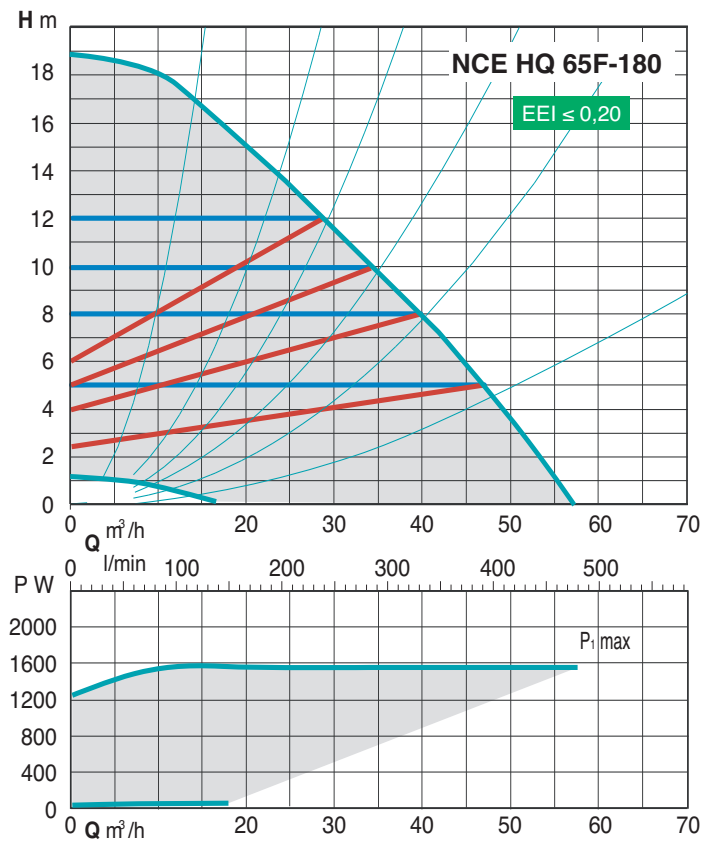
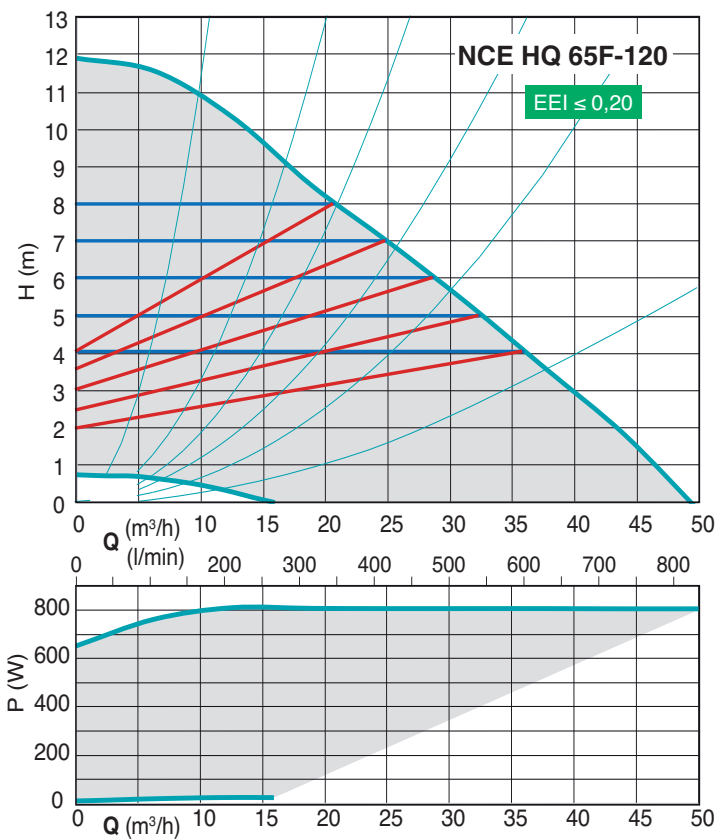
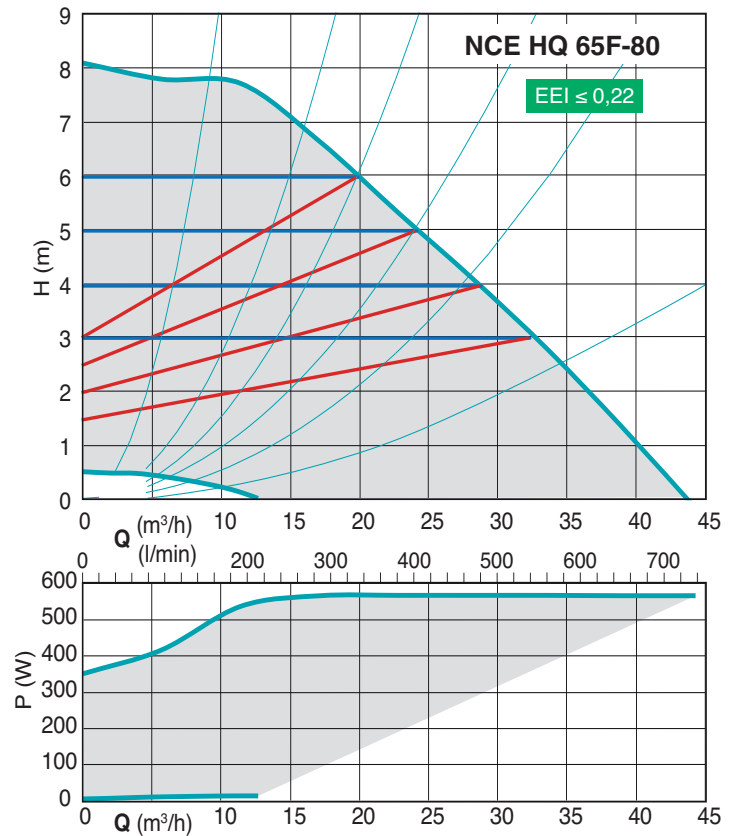
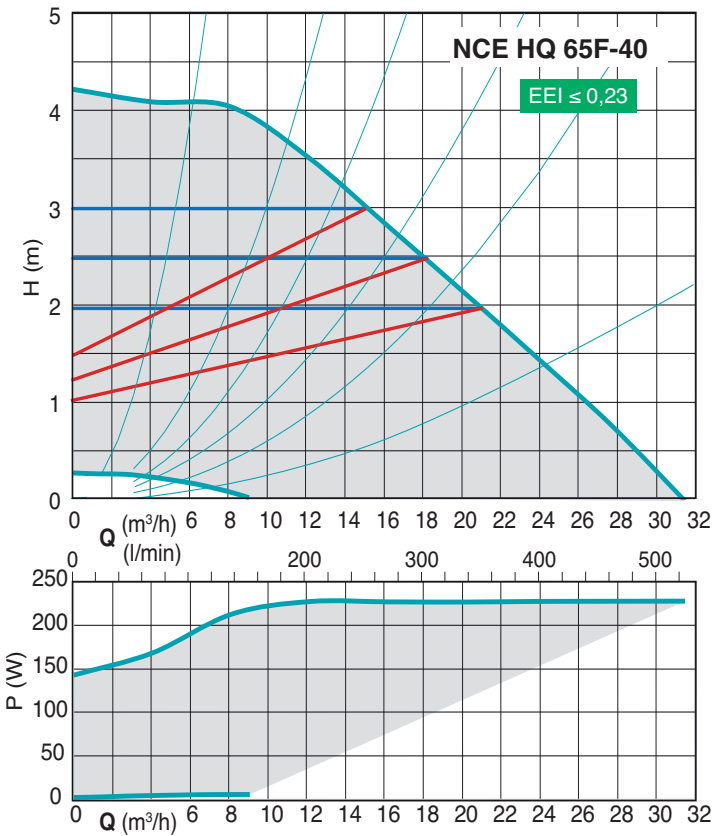

Characteristic curves

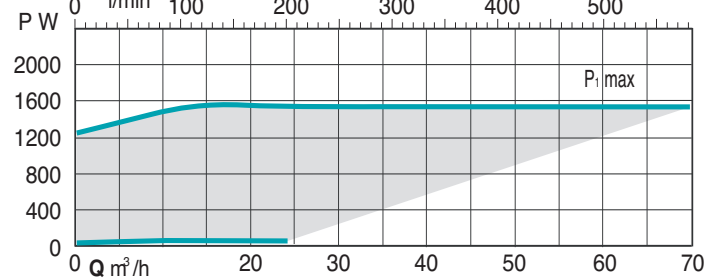
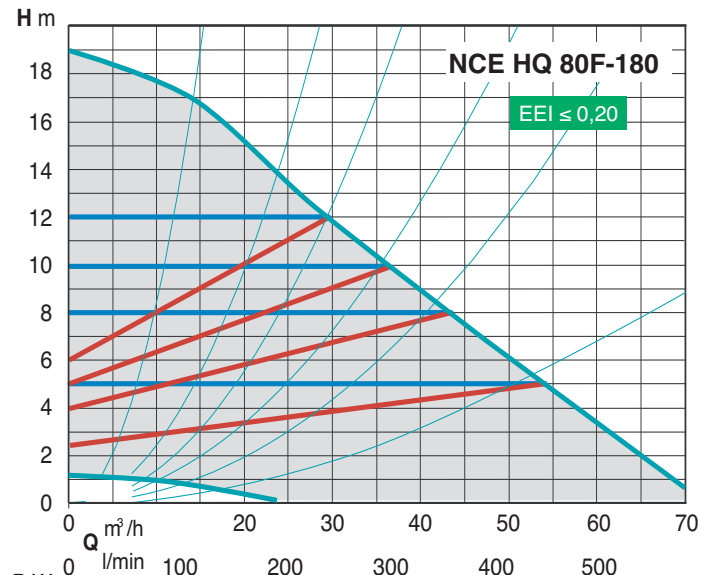
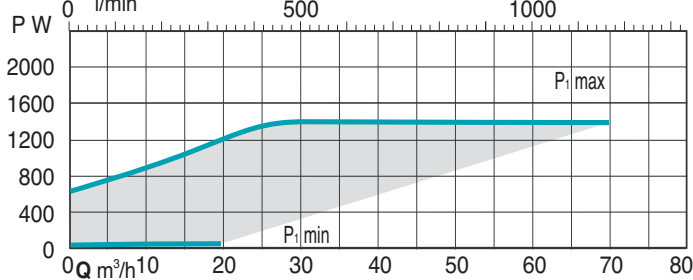
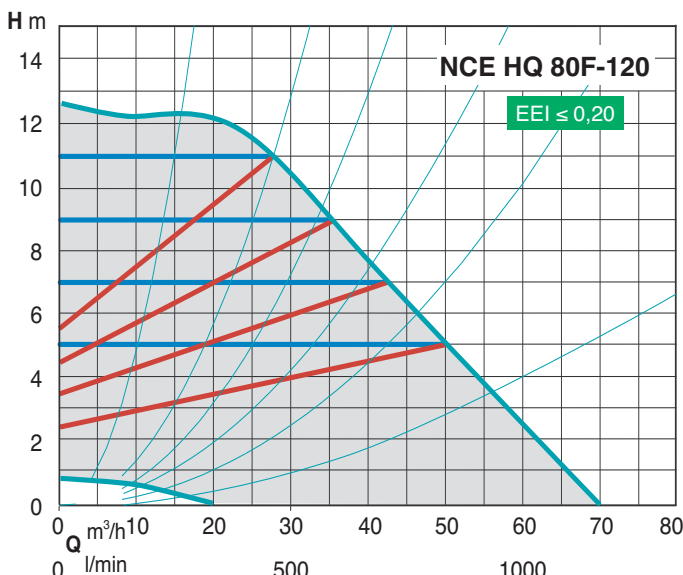
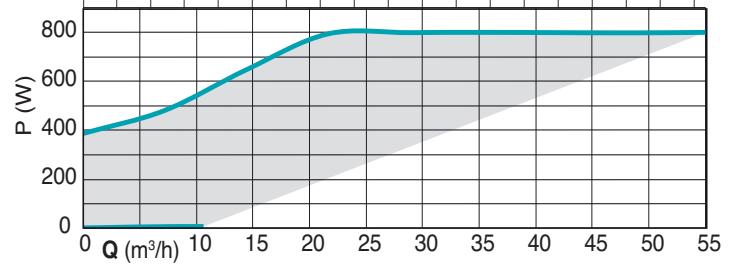
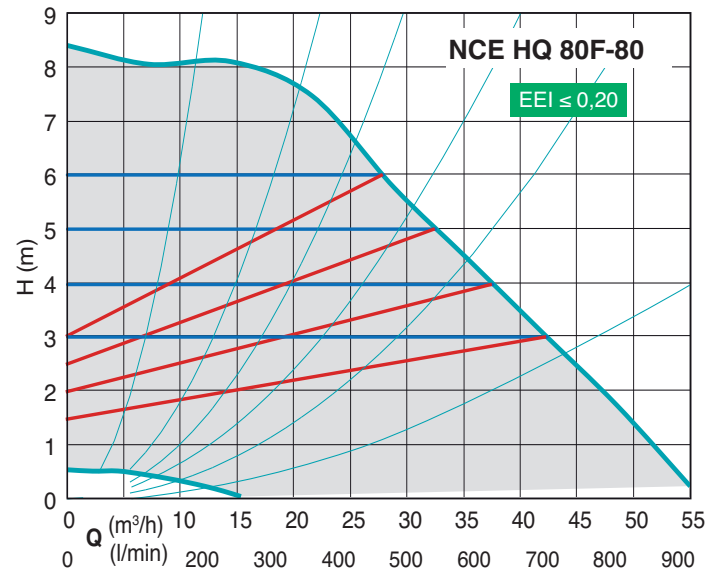
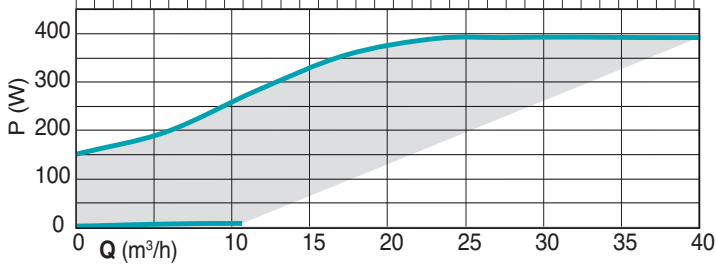
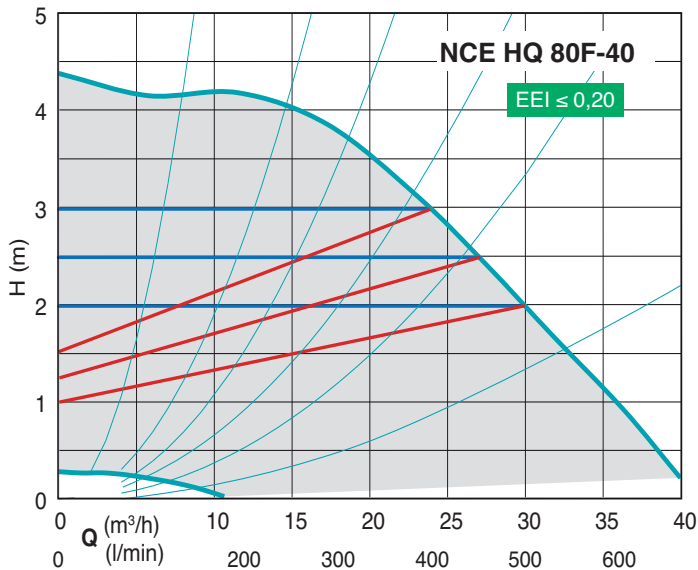

Characteristic curves

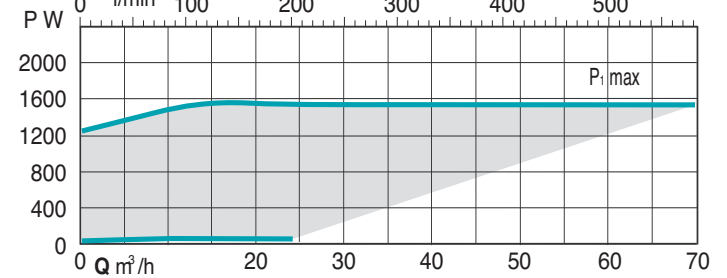
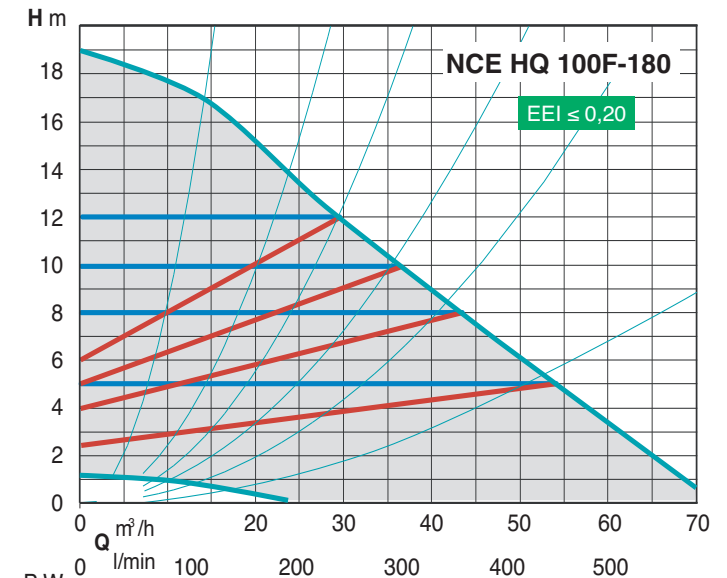
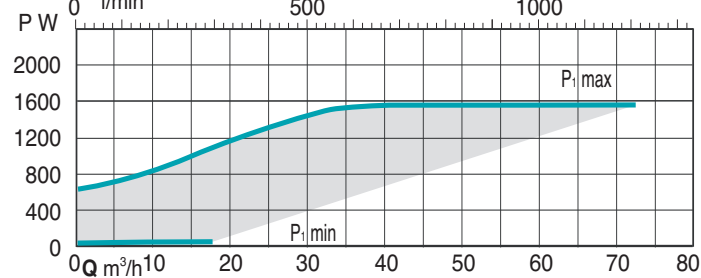
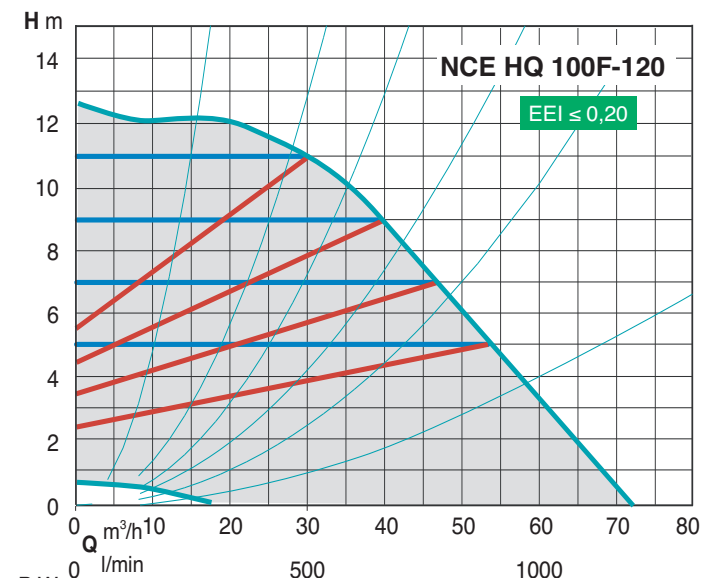
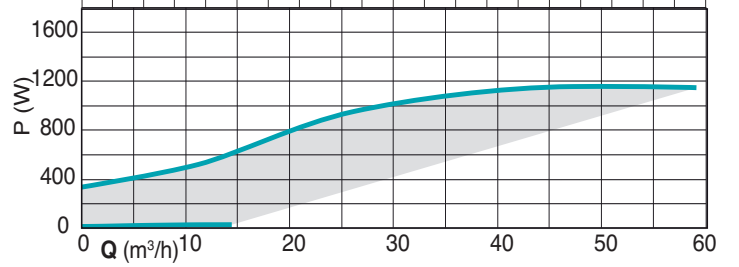
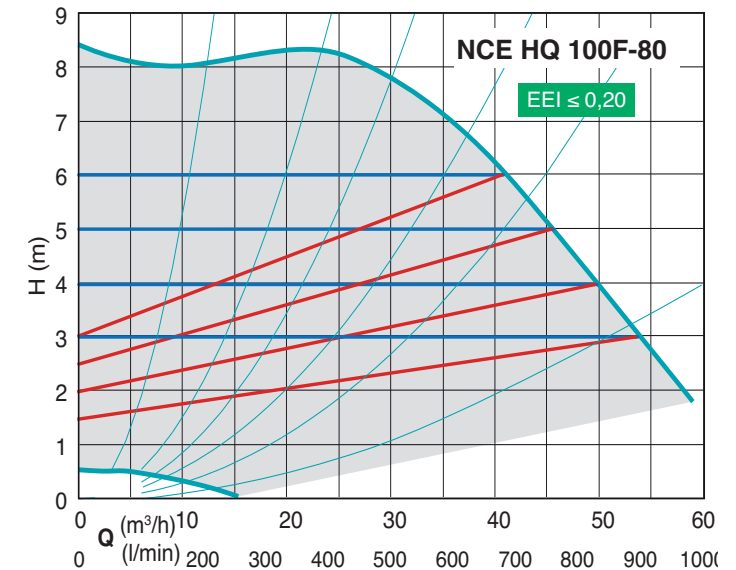
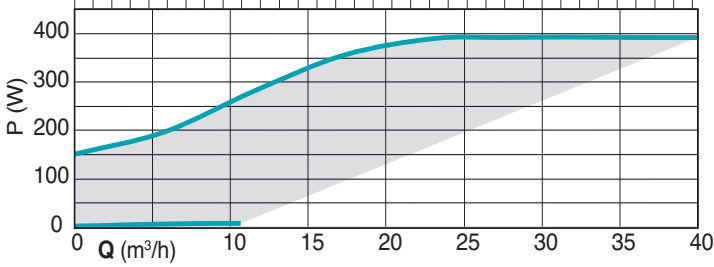
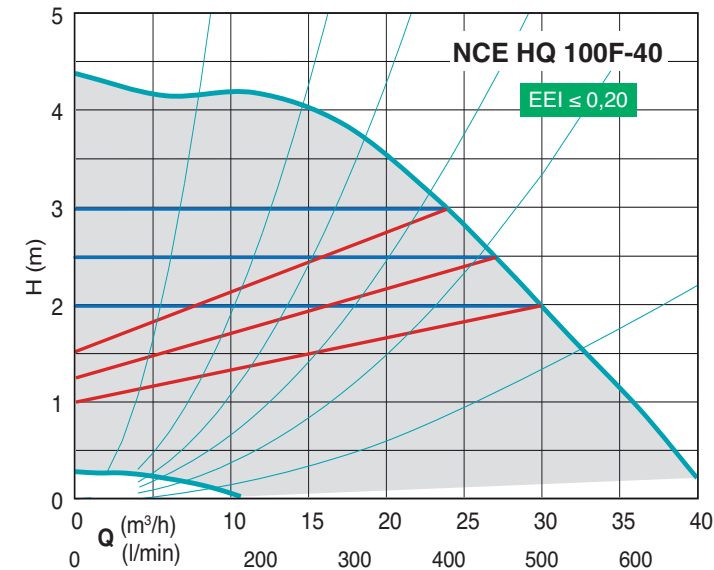

Dimensions and weights

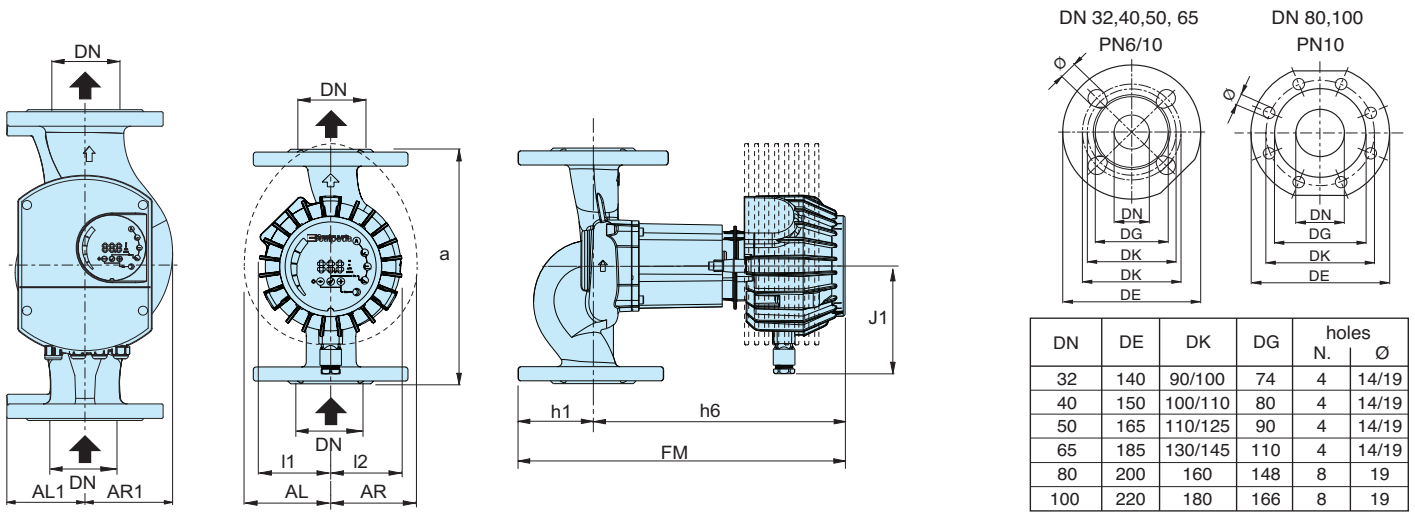

TYPE	DN	H m	Q m³/h	1~ 230 V A max	P ₁ W max	mm											kg
						a	J1	FM	h1	h6	l1	l2	AL	AR	AL1	AR1	
NCE HQ 32F-120/220	32	12	19	1.8	370	220	115	330	65	265	75	75	-	-	-	-	9,1
NCE HQ 40F-40/250	40	4	13	1	110	250	99	270	65	205	59	74	-	-	-	-	8,2
NCE HQ 40F-80/250	40	8	19	1.3	270	250	115	330	65	265	75	75	-	-	-	-	9,6
NCE HQ 40F-120/250	40	12	24	2.3	480	250	115	330	65	265	75	75	-	-	-	-	9,95
NCE HQ 40F-180/250	40	18	25	3.4	680	250	115	330	65	265	-	-	90	90	-	-	14,2
NCE HQ 50F-40/280	50	4	23	1.3	160	280	99	313	65	241	74	92	-	-	-	-	10,8
NCE HQ 50F-80/280	50	8	32	1.7	370	280	115	373	72	301	75	92	-	-	-	-	12,35
NCE HQ 50F-120/280	50	12	36	2.5	560	280	115	373	72	301	75	92	-	-	-	-	13
NCE HQ 50F-180/280	50	18	42	3.6	830	280	115	383	72	311	-	-	92	90	-	-	15,9
NCE HQ 65F-40/340	65	4	31	1.1	230	340	115	386	75	311	83	100	-	-	-	-	15,95
NCE HQ 65F-80/340	65	8	43	2.6	560	340	115	386	75	311	83	103	-	-	-	-	16,65
NCE HQ 65F-120/340	65	12	50	3.5	810	340	115	397	75	322	-	103	90	-	-	-	19,3
NCE HQ 65F-180/340	65	18	57	6,6	1550	340	137	434	75	359	-	-	-	-	94,5	104	-
NCE HQ 80F-40/360	80	4	40	1.8	390	360	115	414	93	321	98	123	-	-	-	-	23,4
NCE HQ 80F-80/360	80	8	53	3.5	800	360	115	425	93	332	98	123	-	-	-	-	25,8
NCE HQ 80F-120/360	80	12	69	6,0	1400	360	137	462	93	369	-	-	-	-	98,5	124	-
NCE HQ 80F-180/360	80	18	72	6,6	1550	360	137	462	93	369	-	-	-	-	98,5	124	-
NCE HQ 100F-40/450	100	4	40	2.4	550	450	115	424	103	321	98	123	-	-	-	-	-
NCE HQ 100F-80/450	100	8	59	4,7	1150	450	137	472	103	369	-	-	-	-	110	124	-
NCE HQ 100F-120/450	100	12	72	6,6	1550	450	137	472	103	369	-	-	-	-	110	124	-
NCE HQ 100F-180/450	100	18	72	6,6	1550	450	137	472	103	369	-	-	-	-	110	124	-

Examples of installations

