

CM/CMP ЧЕРВЯЧНЫЕ РЕДУКТОРЫ WORMGEARBOXES

Технические характеристики

Technical features

Особенностью червячных редукторов серий CM и CMP является высокая степень модульности и большой выбор входных и выходных принадлежностей.

The high degree of modularity is a design feature of CM and CMP wormgearboxes range tank to a wide selection of input and output kits.

Основные характеристики серий CM и CMP:

Main features of CM and CMP range are:

- Литой алюминиевый корпус для габаритов 026, 030, 040, 050, 063, 075, 090 и 110. Чугунный корпус для 130 габарита;
- Двойной конический роликовый подшипник для 090, 110 и 130 габаритов;
- Литой алюминиевый корпус цилиндрической ступени;
- Синтетическая долговечная смазка.
- Die-cast aluminum housing on sizes 026, 030, 040, 050, 063, 075, 090 and 110. Cast iron housing on size 130;
- Double taper roller bearing on sizes 090, 110 and 130;
- Die-cast aluminum housing on pre-stage units;
- Permanent synthetic oil long-life lubrication.

Маркировка

Classification

ЧЕРВЯЧНЫЕ РЕДУКТОРЫ / WORMGEARBOXES

РЕДУКТОР / GEARBOX										
CM	050	U	10	71	B5	SZDX	BRSX	90	B3	VS
Тип Type	Габарит Size	Версия Gearbox Version	Передаточное число Ratio	IEC 	Тип фланца Version	Выходной вал Output shaft	Удерживающий рычаг Torque arm	Угол Angle	Монтажная позиция Mounting position	Опции Options
CM 	026 030 040 050 063	U FD FS FLD FLS FBD FBS	См. таблицу See tables	56.. — 132..	B5 B14	SZDX SZSX DZ	BRDX BRSX	0° 90° 180° 270°	B3 B8 B6 B7 V5 V6	VS
CMIS 	075 090 110 130									

ЧЕРВЯЧНЫЕ РЕДУКТОРЫ С ЦИЛИНДРИЧЕСКОЙ СТУПЕНЬЮ / PRE-STAGE WORMGEARBOXES

РЕДУКТОР / GEARBOX											
CMP	063/050	U	90	63	B14	SZDX	BRSX	90	P4	B3	VS
Тип Type	Габарит Size	Версия Gearbox Version	Передаточное число Ratio	IEC 	Тип фланца Version	Выходной вал Output shaft	Удерживающий рычаг Torque arm	Угол Angle	Монтажная позиция цилиндрической ступени Pre stage mounting position	Монтажная позиция Mounting position	Опции Options
CMP 	056/030 056/040 063/040 063/050 063/063 071/050 071/063 071/075 071/090 080/063 080/075 080/090 080/110 080/130 090/075 090/090 090/110 090/130	U FD FS FLD FLS FBD FBS	Vedere tabella See tables	56.. — 80..	B14	SZDX SZSX DZ	BRDX BRSX	0° 90° 180° 270°	P1 P2 P3 (стандарт) P4	B3 B8 B6 B7 V5 V6	VS

P1 **P2** **P3 (стандарт)** **P4**

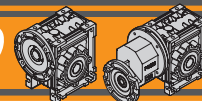

Маркировка

Designation

Версия Gearbox Version	Выходной вал Output shaft	Удерживающий рычаг Torque arm	Угол Angle
<p>U FD FS FLD FLS FBD FBS</p>	<p>SZDX SZSX DZ</p>	<p>BRDX BRSX</p>	<p>90° 90° 180° 0° 270° 270°</p>

ДВИГАТЕЛЬ CM / CM MOTOR				
0.75kW	4p	3ph	50Hz	T1
Мощность Power	Кол-во полюсов Poles	Кол-во фаз Phases	Частота Frequency	Позиция клеммной коробки Terminal box pos.
См. таблицы See tables	2p 4p 6p 8p	1ph 3ph	50Hz 60Hz	T1 (стандарт) T2 T3 T4 T1 T2 T4 T3

CM/CMP

Направление вращения

Direction of rotation

CM

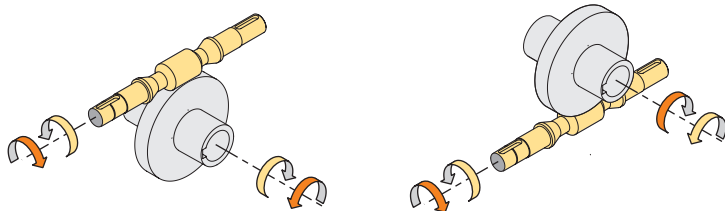

CMP

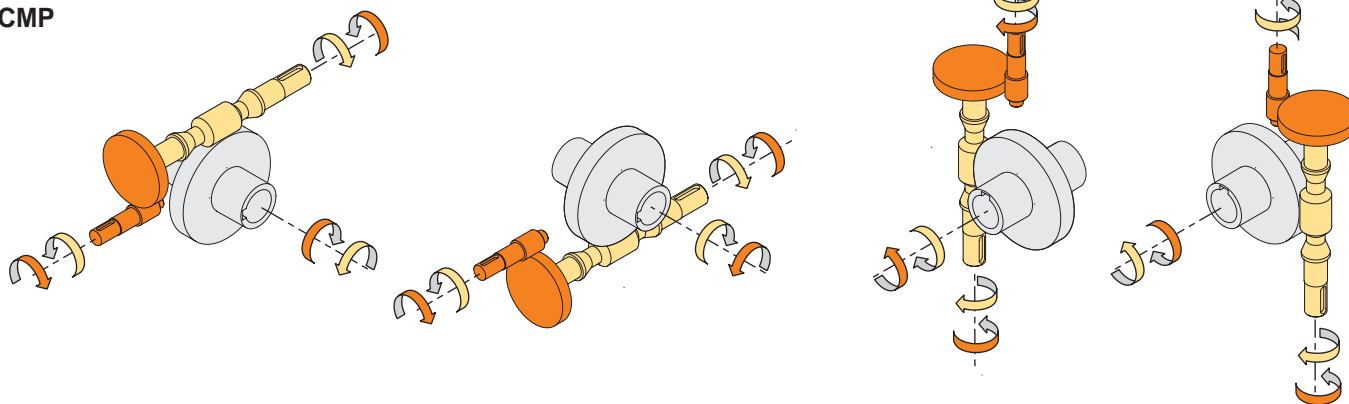

Обозначения

Symbols

n_1	[min ⁻¹]	Скорость на входе / Input speed
n_2	[min ⁻¹]	Скорость на выходе / Output speed
i		Передаточное отношение / Ratio
P_1	[kW]	Номинальная мощность двигателя / Nominal input power
M_2	[Nm]	Вых. момент при мощности P_1 / Output torque referred to P_1
P_{n1}	[kW]	Номинальная входная мощность / Nominal input power
M_{n2}	[Nm]	Номинальный вых. момент при мощности P_{n1} / Nominal output torque referred to P_{n1}

sf		Сервис фактор / Service factor
Rd	%	Динамическая эффективность / Dynamic efficiency
Rs	%	Статическая эффективность / Static efficiency
R_2	[N]	Радиальная нагрузка / Permitted output radial load
A_2	[N]	Осевая нагрузка / Permitted output axial load
Z		Число зацепления червячной передачи / Worm starts
β		Угол наклона линии зуба / Helix angle

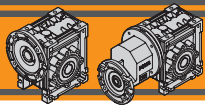

CM/CMP

ЧЕРВЯЧНЫЕ РЕДУКТОРЫ WORMGEARBOXES

Смазка

Lubrication

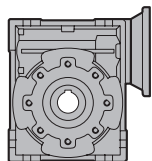

CM	Количество смазки (литры) / Oil quantity (litres)					
	B3	B8	B6	B7	V5	V6
026	0.015					
030	0.03					
040	0.07					
050	0.1					
063	0.25					
075	0.3					
090	0.85					
110	1.5					
130	4.5	3.3	3.5	3.5	4.5	3.3

На весь срок эксплуатации
Life lubricated

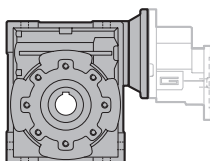

CMP	Количество смазки (литры) / Oil quantity (litres)					
	B3	B8	B6	B7	V5	V6
056/030	0.03					
056/040 - 063/040	0.07					
063/050 - 071/050	0.1					
063/063 - 071/063 - 080/063	0.25					
071/075 - 080/075 - 090/075	0.4					
071/090 - 080/090 - 090/090	0.85					
080/110 - 090/110	1.5					
080/130 - 090/130	4.5	3.3	3.5	3.5	4.5	3.3

На весь срок эксплуатации
Life lubricated

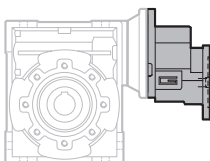

CMP				
056/030 056/040	063/040 063/050 063/063	071/050 071/063 071/075 071/090	080/063 080/075 080/090 080/110 080/130	090/075 090/090 090/110 090/130

На весь срок эксплуатации
Life lubricated

Монтажные позиции / Mounting positions

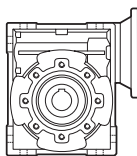

B3
(Стандарт)

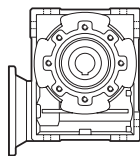

B8

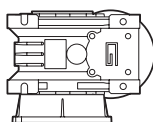

B6

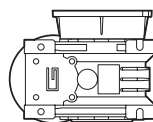

B7

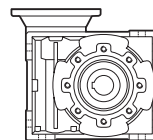

V5

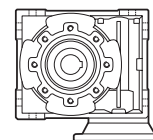

V6

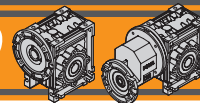

Радиальные нагрузки

Radial loads

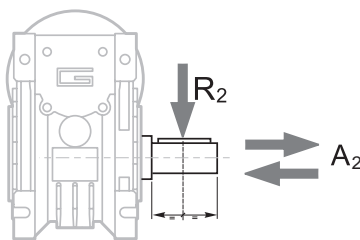

$$A_2 = R_2 \times 0.2$$

n ₂ [min ⁻¹]	R ₂ [N]								
	CM026	CM030	CM040	CM050	CM063	CM075	CM090	CM110	CM130
187	400	674	1264	1770	2445	2824	3161	5058	5732
140	490	743	1392	1949	2692	3110	3481	5570	6313
93	580	851	1596	2234	3085	3564	3990	6384	7235
70	610	936	1754	2456	3392	3918	4386	7018	7953
56	610	1008	1890	2646	3654	4221	4725	7560	8567
47	610	1069	2004	2805	3874	4475	5009	8014	9083
35	610	1179	2210	3095	4273	4937	5526	8842	10021
28	610	1270	2381	3334	4603	5318	5953	9524	10794
23	610	1356	2542	3559	4915	5678	6356	10170	11526
18	610	1471	2759	3862	5334	6162	6897	11036	12507
14	610	1600	3000	4200	5800	6700	7500	12000	13600
	CMP... /030	CMP... /040	CMP... /050	CMP... /063	CMP... /075	CMP... /090	CMP... /110	CMP... /130	

CM/CMP

Если суммарная радиальная нагрузка не приходится на центр выходного вала, необходимо рассчитать её по формуле:

When the resulting radial load is not applied on the centre line of the shaft it is necessary to calculate the effective load with the following formula:

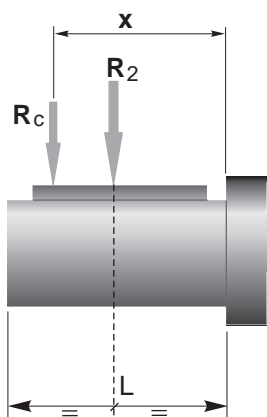

	CM	CM / CMP							
	026	030	040	050	063	075	090	110	130
a	56	65	84	101	120	131	182	176	188
b	43	50	64	76	95	101	122	136	148
R _{2MAX}	610	1600	3000	4200	5800	6700	7500	12000	13600

$$R_c = \frac{R_2 \cdot a}{(b+x)} \leq R_{2MAX}$$

$$R \leq R_c$$

a, b = значения из таблицы
a, b = values given in the table

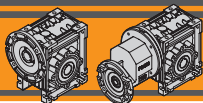

Характеристики зубьев

Toothing data

	Данные червячной шестерни Worm wheel data	Передаточное число / Ratio											
		5	7.5	10	15	20	25	30	40	50	60	80	100
CM026	Z	6	4	3	2	2		1	1	1	1		
	β	34° 35'	24° 41'	19° 1'	12° 57'	10° 30'		6° 33'	5° 17'	4° 26'	3° 49'		
CM030	Z	6	4	3	2	2	2	1	1	1	1	1	1
	β	27° 4'	24° 28'	18° 50'	12° 49'	10° 23'	8° 43'	6° 29'	5° 14'	4° 23'	3° 46'	2° 57'	2° 25'
CM040	Z	6	4	3	2	2	2	1	1	1	1	1	1
	β	34° 19'	24° 28'	18° 50'	12° 49'	10° 23'	8° 43'	6° 29'	5° 14'	4° 23'	3° 46'	2° 57'	2° 25'
CM050	Z	6	4	3	2	2	2	1	1	1	1	1	1
	β	33° 37'	23° 54'	18° 23'	12° 29'	10° 6'	8° 28'	6° 19'	5° 5'	4° 15'	3° 39'	2° 51'	2° 20'
CM063	Z	6	4	3	2	2	2	1	1	1	1	1	1
	β	34° 23'	24° 31'	18° 53'	12° 50'	10° 24'	8° 44'	6° 30'	5° 14'	4° 23'	3° 47'	2° 57'	2° 25'
CM075	Z		4	3	2	2	2	1	1	1	1	1	1
	β		26° 17'	20° 20'	13° 52'	11° 18'	9° 32'	7° 2'	5° 42'	4° 48'	4° 8'	3° 14'	2° 40'
CM090	Z		4	3	2	2	2	1	1	1	1	1	1
	β		29° 11'	22° 43'	15° 36'	12° 50'	10° 53'	7° 56'	6° 30'	5° 29'	4° 45'	3° 45'	3° 6'
CM110	Z		4	3	2	2	2	1	1	1	1	1	1
	β		28° 14'	21° 56'	15° 1'	14° 41'	12° 34'	7° 38'	7° 28'	6° 21'	5° 32'	4° 24'	3° 39'
CM130	Z		4	3	2	2	2	1	1	1	1	1	1
	β		28° 43'	22° 20'	15° 19'	13° 47'	11° 54'	7° 48'	7° 00'	6° 01'	5° 16'	4° 08'	3° 27'

КПД

Efficiency

	n ₁ [об/мин]	КПД Efficiency	Передаточное число / Ratio											
			5	7.5	10	15	20	25	30	40	50	60	80	100
CM026	2800	Rd	89	87	85	83	80		73	68	64	60		
	1400		87	84	83	78	74		66	61	57	53		
	900		84	83	80	75	71		61	57	52	48		
		Rs	72	71	68	61	56	46	41	36	34			
CM030	2800	Rd	89	88	86	84	81	78	74	70	65	62	57	52
	1400		86	85	84	79	75	72	67	62	58	55	48	43
	900		84	83	81	75	71	68	62	58	53	49	43	39
		Rs	72	67	63	55	50	43	39	35	31	27	23	21
CM040	2800	Rd	90	89	87	84	83	80	77	73	69	66	60	56
	1400		88	86	84	81	78	74	70	65	60	58	52	46
	900		86	84	82	77	74	70	66	60	57	53	46	41
		Rs	74	71	67	60	55	51	45	40	36	32	28	24
CM050	2800	Rd	91	90	88	86	84	82	78	74	71	68	62	58
	1400		89	87	85	82	79	76	72	67	63	60	54	49
	900		87	85	84	79	75	72	68	62	59	55	48	43
		Rs	73	70	66	59	55	51	44	39	35	32	27	23
CM063	2800	Rd	91	90	88	86	84	83	79	76	73	70	65	60
	1400		90	88	86	84	81	78	75	70	66	63	57	52
	900		89	86	84	81	78	75	70	65	61	58	52	47
		Rs	73	71	67	60	55	51	45	40	36	33	28	24
CM075	2800	Rd		90	89	87	85	84	81	78	75	72	68	63
	1400			89	87	84	83	80	77	73	69	66	60	56
	900			87	85	83	80	77	73	68	64	61	55	50
		Rs		71	68	61	57	53	46	42	38	35	29	26
CM090	2800	Rd		91	90	88	86	85	83	80	78	75	71	67
	1400			90	88	86	84	83	79	76	72	69	64	60
	900			88	87	84	82	80	76	72	68	65	60	55
		Rs		73	70	64	60	56	49	45	41	38	32	28
CM110	2800	Rd		90	89	88	87	86	82	81	79	77	73	70
	1400			89	88	86	85	84	80	79	76	73	68	64
	900			88	87	84	83	82	78	75	71	68	63	59
		Rs		72	69	63	62	59	48	46	44	41	36	32
CM130	2800	Rd		90	89	88	87	86	82	80	79	77	72	70
	1400			89	88	86	84	83	79	76	75	73	69	64
	900			88	87	84	82	81	77	74	73	70	64	59
		Rs		72	69	62	61	59	49	46	43	39	34	30



Теоретическое значение КПД на первом периоде эксплуатации
Theoretical efficiency of the gearbox after the first running period

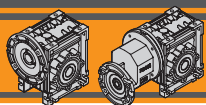

CM/CMP

ЧЕРВЯЧНЫЕ РЕДУКТОРЫ WORMGEARBOXES

Таблицы выбора

Technical data

P ₁ [кВт]	n ₂ [об/мин]	M ₂ [Нм]	sf	i				P ₁ [кВт]	n ₂ [об/мин]	M ₂ [Нм]	sf	i				
0.06								0.09								
56A4 (1400 об/мин)	280	2	7.3	5	CM026			56A2 (2800 об/мин)	31	17	1.6	90				
	187	3	5.4	7.5	CM026				28	16	0.7	100	CM030	CMP056/030	B14	
	140	3	4.1	10	CM026				23	21	1.1	120		CMP056/030	B14	
	93	5	2.9	15	CM026				19	24	0.9	150		CMP056/030	B14	
	70	6	2.3	20	CM026											
	47	8	1.9	30	CM026			47	12	2.4	60		CM040		B5/B14	
	35	10	1.4	40	CM026			47	13	3.4	60			CMP056/040	B14	
	28	12	1.1	50	CM026			37	16	2.8	75			CMP056/040	B14	
	23	13	0.9	60	CM026			31	18	3.1	90			CMP056/040	B14	
								23	22	2.2	120			CMP056/040	B14	
	280	2	10.2	5	CM030		B5/B14	19	26	1.8	150			CMP056/040	B14	
	187	3	7.7	7.5	CM030		B5/B14	16	29	1.5	180			CMP056/040	B14	
	140	3	6.1	10	CM030		B5/B14	12	33	1.2	240			CMP056/040	B14	
	93	5	4.3	15	CM030		B5/B14	9.3	37	1.0	300			CMP056/040	B14	
	70	6	3.1	20	CM030		B5/B14									
	56	7	2.7	25	CM030		B5/B14	56B4 (1400 об/мин)	280	3	4.9	5	CM026		B14	
	47	8	2.7	30	CM030		B5/B14		187	4	3.6	7.5	CM026		B14	
	35	10	2.0	40	CM030		B5/B14		140	5	2.7	10	CM026		B14	
	28	12	1.6	50	CM030		B5/B14		93	7	1.9	15	CM026		B14	
	23	14	1.3	60	CM030		B5/B14		70	9	1.5	20	CM026		B14	
	23	16	1.6	60		CMP056/030	B14		47	12	1.2	30	CM026		B14	
	19	19	1.4	75		CMP056/030	B14		35	15	0.9	40	CM026		B14	
	18	16	1.0	80	CM030		B5/B14		28	17	0.7	50	CM026		B14	
	16	21	1.5	90		CMP056/030	B14									
	14	18	0.8	100	CM030		B5/B14	280	3	6.8	5		CM030		B5/B14	
	12	26	1.1	120		CMP056/030	B14		187	4	5.1	7.5	CM030		B5/B14	
	9.3	29	0.9	150		CMP056/030	B14		140	5	4.1	10	CM030		B5/B14	
									93	7	2.9	15	CM030		B5/B14	
	28	12	3.2	50	CM040		B5/B14		70	9	2.1	20	CM030		B5/B14	
	23	14	2.5	60	CM040		B5/B14		56	11	1.8	25	CM030		B5/B14	
	23	17	3.4	60		CMP056/040	B14		47	12	1.8	30	CM030		B5/B14	
	19	20	2.6	75		CMP056/040	B14		35	15	1.3	40	CM030		B5/B14	
	18	17	1.9	80	CM040		B5/B14		28	18	1.1	50	CM030		B5/B14	
	16	23	3.1	90		CMP056/040	B14		23	20	0.8	60	CM030		B5/B14	
	14	19	1.6	100	CM040		B5/B14		23	24	1.1	60		CMP056/030	B14	
	12	28	2.2	120		CMP056/040	B14		19	29	0.9	75		CMP056/030	B14	
	9.3	32	1.8	150		CMP056/040	B14		18	24	0.6	80	CM030		B5/B14	
	7.8	35	1.5	180		CMP056/040	B14		16	32	1.0	90		CMP056/030	B14	
	5.8	41	1.1	240		CMP056/040	B14		12	38	0.8	120		CMP056/030	B14	
	4.7	46	0.9	300		CMP056/040	B14									
									35	16	2.6	40	CM040		B5/B14	
									28	18	2.1	50	CM040		B5/B14	
									23	21	1.7	60	CM040		B5/B14	
									23	25	2.3	60		CMP056/040	B14	
									19	30	1.7	75		CMP056/040	B14	
									18	26	1.3	80	CM040		B5/B14	
									16	34	2.1	90		CMP056/040	B14	
									14	28	1.1	100	CM040		B5/B14	
									12	42	1.5	120		CMP056/040	B14	
									9.3	48	1.2	150		CMP056/040	B14	
									7.8	53	1.0	180		CMP056/040	B14	
									5.8	62	0.8	240		CMP056/040	B14	
									35	16	2.6	40	CM040		B5/B14	
									28	18	2.1	50	CM040		B5/B14	
									23	21	1.7	60	CM040		B5/B14	
									23	25	2.3	60		CMP056/040	B14	
									19	30	1.7	75		CMP056/040	B14	
									18	26	1.3	80	CM040		B5/B14	
									16	34	2.1	90		CMP056/040	B14	
									14	28	1.1	100	CM040		B5/B14	
									12	42	1.5	120		CMP056/040	B14	
									9.3	48	1.2	150		CMP056/040	B14	
									7.8	53	1.0	180		CMP056/040	B14	
									5.8	62	0.8	240		CMP056/040	B14	
									63A6 (900 об/мин)	180	4	5.2	5	CM030		B5/B14
									120	6	4.0	7.5	CM030		B5/B14	
									90	8	3.1	10	CM030		B5/B14	
									60	11	2.3	15	CM030		B5/B14	
									45	14	1.6	20	CM030		B5/B14	
									36	16	1.4	25	CM030		B5/B14	
									30	18	1.5	30	CM030		B5/B14	
									23	22	1.0	40	CM030		B5/B14	
									18	25	0.9	50	CM030		B5/B14	

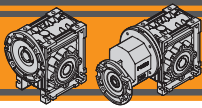

Соединительные адаптеры для моторов IEC

IEC Motor adapters

	IEC	N	M	P	D	i																	
						5	7.5	10	15	20	25	30	40	50	60	80	100						
CM026	56B14	50	65	80	9																		
CM030	63B5	95	115	140	11																		
	63B14	60	75	90																			
	56B5	80	100	120	9	B	B	B	B	B	B	B	B	B									
	56B14	50	65	80																			
CM040	71B5	110	130	160	14																		
	71B14	70	85	105																			
	63B5	95	115	140	11	B	B	B	B	B	B	B	B										
	63B14	60	75	90																			
	56B5	80	100	120	9	BS	BS	BS	BS	BS	BS	BS	BS	BS	B	B	B	B					
	56B14	50	65	80																			
CM050	80B5	130	165	200	19																		
	80B14	80	100	120																			
	71B5	110	130	160	14	B	B	B	B	B	B	B											
	71B14	70	85	105																			
	63B5	95	115	140	11	BS	BS	BS	BS	BS	BS	BS	BS	B	B	B	B						
	63B14	60	75	90																			
CM063	90B5	130	165	200	24																		
	90B14	95	115	140																			
	80B5	130	165	200	19	B	B	B	B	B	B	B											
	80B14	80	100	120																			
	71B5	110	130	160	14	BS	BS	BS	BS	BS	BS	BS	BS	B	B	B							
	71B14	70	85	105																			
CM075	63B5	95	115	140	11									BS	BS	BS	B	B					
	100/112B5	180	215	250	28																		
	100/112B14	110	130	160																			
	90B5	130	165	200	24		B	B	B														
	90B14	95	115	140																			
	80B5	130	165	200	19	BS	BS	BS	B	B	B	B											
CM090	80B14	80	100	120																			
	71B5	110	130	160	14									BS	BS	BS	B	B					
	100/112B5	180	215	250	28																		
	100/112B14	110	130	160																			
	90B5	130	165	200	24		B	B	B	B	B												
	90B14	95	115	140																			
CM110	80B5	130	165	200	19	BS	BS	BS	BS	BS	BS	B	B	B	B								
	132B5	230	265	300	38																		
	132B14	130	165	200																			
	100/112B5	180	215	250	28		B	B	B	B	B												
	100/112B14	110	130	160																			
	90B5	130	165	200	24	BS	BS	BS	BS	BS	B	B	B	B									
CM130	90B14	95	115	140																			
	80B5	130	165	200	19									BS	BS	BS	BS	B	B				
	132B5	230	265	300	38																		
	132B14	130	165	200																			
	100/112B5	180	215	250	28		B	B	B	B	B	B											
CM130	90B5	130	165	200	24	BS	BS	BS	BS	BS	BS	BS	B	B	B	B							
	80B5	130	165	200	19													BS	BS	BS	BS		

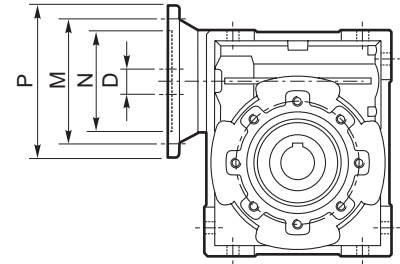

ВНИМАНИЕ

Серым выделены возможные варианты соединений редукторов с моторами в зависимости от габарита редуктора и его передаточного числа.

N.B. Grey areas indicate motor inputs available on each size of unit.

B/BS = Необходимо применение переходной втулки

B/BS = Metal shaft sleeve

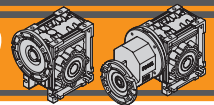

Соединительные адаптеры для моторов IEC

IEC Motor adapters

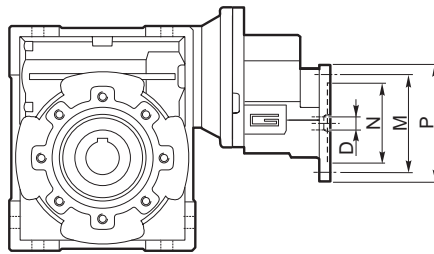

CMP	IEC	N	M	P	D	i (i ₁ x i ₂)							
						60 (3x20)	75 (3x25)	90 (3x30)	120 (3x40)	150 (3x50)	180 (3x60)	240 (3x80)	300 (3x100)
056/030	56 B14	50	65	80	9								
056/040						B	B	B	B				
063/040	63 B14	60	75	90	11								
063/050						B	B	B					
063/063						BS	BS	BS	B	B	B		
071/050	71 B14	70	85	105	14								
071/063						B	B	B					
071/075						B	B	B	B				
071/090						BS	BS	BS	B	B	B		
080/063	80 B14	80	100	120	19								
080/075													
080/090						B	B	B					
080/110						BS	BS	B	B	B	B		
080/130						BS	BS	BS	BS	B	B	B	B
090/075	90 B14 90 B5	95 130	115 165	140 200	24								
090/090						B	B	B					
090/110						BS	BS	B	B	B	B		
090/130						BS	BS	BS	BS	B	B	B	B

ВНИМАНИЕ

Серым выделены возможные варианты соединений редукторов с моторами в зависимости от габарита редуктора и его передаточного числа.

B/BS = Необходимо применение переходной втулки

N.B. Grey areas indicate motor inputs available on each size of unit.

B/BS = Metal shaft sleeve

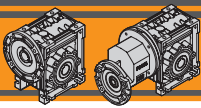

Габаритные размеры

Dimensions

CM 026 U

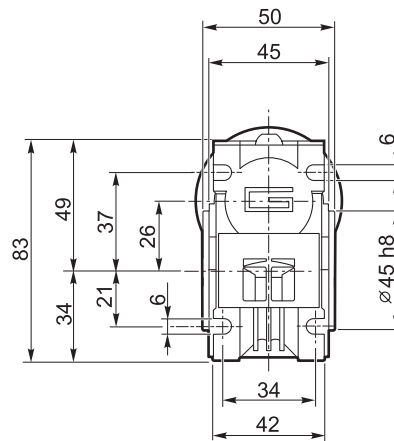
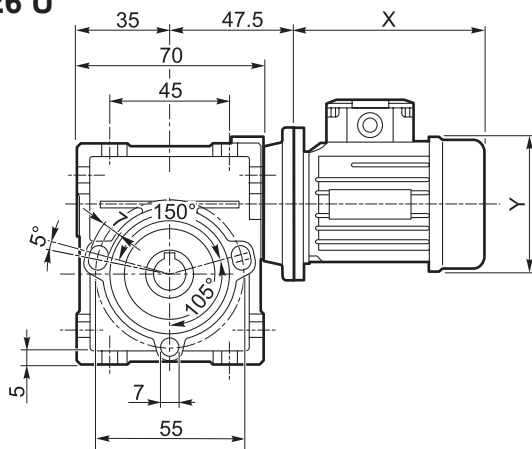

CM 026 FC

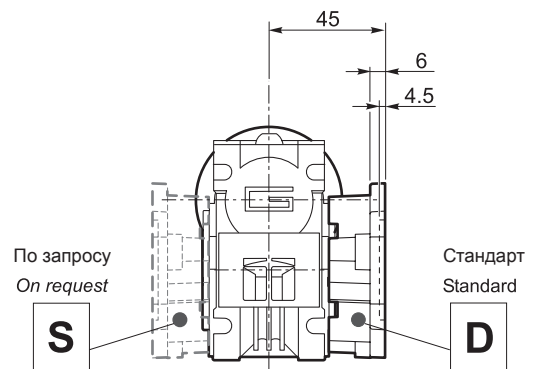
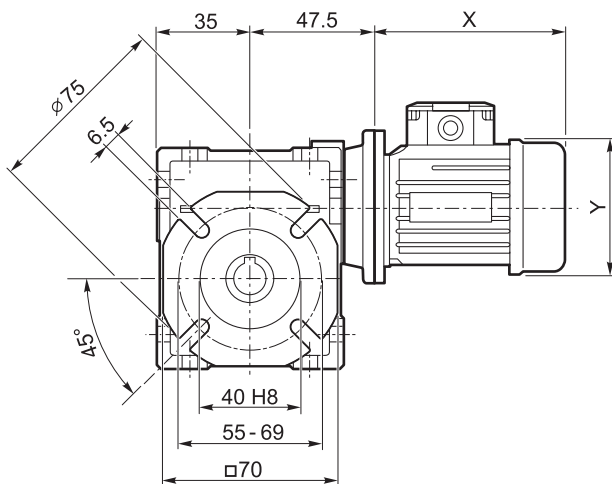

Kg
0.8

CMIS 026 ..

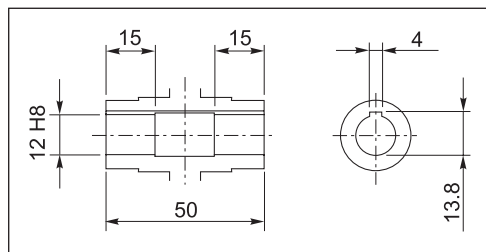
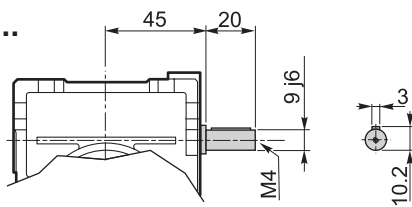

Выходной полый вал / Hollow output shaft

CM 026 .. с фланцем NEMA23 / with NEMA23 flange

Толщина фланца зависит от длины входного вала.
Flange's thickness may vary depending on motorshaft's length.

Валы соединяются посредством втулки или муфты в зависимости от диаметра вала двигателя.
Connection with sleeve or coupling depending on motorshaft's diameter.