

# CM/CMP ЧЕРВЯЧНЫЕ РЕДУКТОРЫ WORMGEARBOXES

## Технические характеристики

## Technical features

Особенностью червячных редукторов серий CM и CMP является высокая степень модульности и большой выбор входных и выходных принадлежностей.

The high degree of modularity is a design feature of CM and CMP wormgearboxes range tank to a wide selection of input and output kits.

Основные характеристики серий CM и CMP:

Main features of CM and CMP range are:

- Литой алюминиевый корпус для габаритов 026, 030, 040, 050, 063, 075, 090 и 110. Чугунный корпус для 130 габарита;
- Die-cast aluminum housing on sizes 026, 030, 040, 050, 063, 075, 090 and 110. Cast iron housing on size 130;
- Двойной конический роликовый подшипник для 090, 110 и 130 габаритов;
- Double taper roller bearing on sizes 090, 110 and 130;
- Литой алюминиевый корпус цилиндрической ступени;
- Die-cast aluminum housing on pre-stage units;
- Синтетическая долговечная смазка.
- Permanent synthetic oil long-life lubrication.

## Маркировка

## Classification

### ЧЕРВЯЧНЫЕ РЕДУКТОРЫ / WORMGEARBOXES

РЕДУКТОР / GEARBOX										
CM	050	U	10	71	B5	SZDX	BRSX	90	B3	VS
Тип Type	Габарит Size	Версия Gearbox Version	Передаточное число Ratio	IEC 	Тип фланца Version	Выходной вал Output shaft	Удерживающий рычаг Torque arm	Угол Angle	Монтажная позиция Mounting position	Опции Options
<b>CM</b> 	<b>026</b> <b>030</b> <b>040</b> <b>050</b> <b>063</b>	<b>U</b> <b>FD</b> <b>FS</b> <b>FLD</b> <b>FLS</b> <b>FBD</b> <b>FBS</b>	См. таблицу See tables	<b>56..</b> — <b>132..</b>	<b>B5</b> <b>B14</b>	<b>SZDX</b> <b>SZSX</b> <b>DZ</b>	<b>BRDX</b> <b>BRSX</b>	<b>0°</b> <b>90°</b> <b>180°</b> <b>270°</b>	<b>B3</b> <b>B8</b> <b>B6</b> <b>B7</b> <b>V5</b> <b>V6</b>	<b>VS</b>
<b>CMIS</b> 	<b>075</b> <b>090</b> <b>110</b> <b>130</b>									

### ЧЕРВЯЧНЫЕ РЕДУКТОРЫ С ЦИЛИНДРИЧЕСКОЙ СТУПЕНЬЮ / PRE-STAGE WORMGEARBOXES

РЕДУКТОР / GEARBOX											
CMP	063/050	U	90	63	B14	SZDX	BRSX	90	P4	B3	VS
Тип Type	Габарит Size	Версия Gearbox Version	Передаточное число Ratio	IEC 	Тип фланца Version	Выходной вал Output shaft	Удерживающий рычаг Torque arm	Угол Angle	Монтажная позиция цилиндрической ступени Pre stage mounting position	Монтажная позиция Mounting position	Опции Options
<b>CMP</b> 	<b>056/030</b> <b>056/040</b> <b>063/040</b> <b>063/050</b> <b>063/063</b> <b>071/050</b> <b>071/063</b> <b>071/075</b> <b>071/090</b> <b>080/063</b> <b>080/075</b> <b>080/090</b> <b>080/110</b> <b>080/130</b> <b>090/075</b> <b>090/090</b> <b>090/110</b> <b>090/130</b>	<b>U</b> <b>FD</b> <b>FS</b> <b>FLD</b> <b>FLS</b> <b>FBD</b> <b>FBS</b>	Vedere tabella See tables	<b>56..</b> — <b>80..</b>	<b>B14</b>	<b>SZDX</b> <b>SZSX</b> <b>DZ</b>	<b>BRDX</b> <b>BRSX</b>	<b>0°</b> <b>90°</b> <b>180°</b> <b>270°</b>	<b>P1</b> <b>P2</b> <b>P3 (стандарт)</b> <b>P4</b>	<b>B3</b> <b>B8</b> <b>B6</b> <b>B7</b> <b>V5</b> <b>V6</b>	<b>VS</b>

P1      P2      P3 (стандарт)      P4

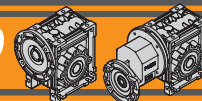

## Маркировка

## Designation

Версия Gearbox Version	Выходной вал Output shaft	Удерживающий рычаг Torque arm	Угол Angle
<p><b>U</b>      <b>FD</b>      <b>FS</b> <b>FLD</b>      <b>FLS</b> <b>FBD</b>      <b>FBS</b></p>	<p><b>SZDX</b>      <b>SZSX</b>      <b>DZ</b></p>	<p><b>BRDX</b>      <b>BRSX</b></p>	<p><b>90°</b>      <b>90°</b> <b>180°</b>      <b>0°</b> <b>270°</b>      <b>270°</b></p>

ДВИГАТЕЛЬ CM / CM MOTOR				
0.75kW	4p	3ph	50Hz	T1
Мощность Power	Кол-во полюсов Poles	Кол-во фаз Phases	Частота Frequency	Позиция клеммной коробки Terminal box pos.
См. таблицы See tables	<b>2p</b> <b>4p</b> <b>6p</b> <b>8p</b>	<b>1ph</b> <b>3ph</b>	<b>50Hz</b> <b>60Hz</b>	<b>T1</b> (стандарт) <b>T2</b> <b>T3</b> <b>T4</b>  <b>T1</b> <b>T2</b> <b>T4</b> <b>T3</b>

CM/CMP

## Направление вращения

## Direction of rotation

CM

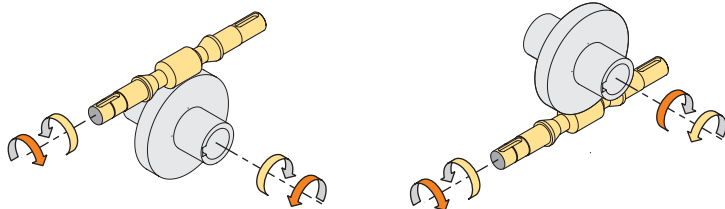

CMP

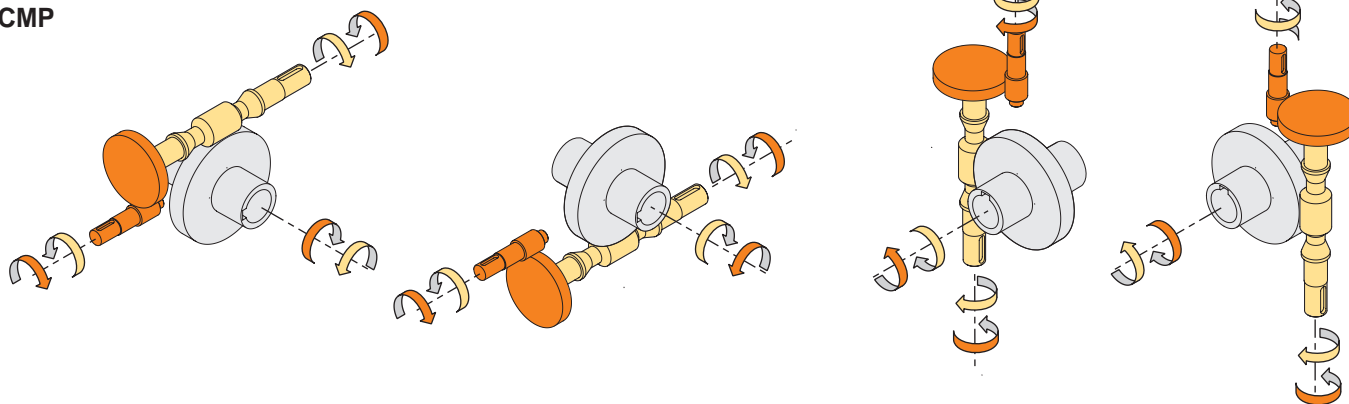

## Обозначения

## Symbols

$n_1$	[min <sup>-1</sup> ]	Скорость на входе / <i>Input speed</i>
$n_2$	[min <sup>-1</sup> ]	Скорость на выходе / <i>Output speed</i>
$i$		Передаточное отношение / <i>Ratio</i>
$P_1$	[kW]	Номинальная мощность двигателя / <i>Nominal input power</i>
$M_2$	[Nm]	Вых. момент при мощности $P_1$ / <i>Output torque referred to <math>P_1</math></i>
$P_{n1}$	[kW]	Номинальная входная мощность / <i>Nominal input power</i>
$M_{n2}$	[Nm]	Номинальный вых. момент при мощности $P_{n1}$ / <i>Nominal output torque referred to <math>P_{n1}</math></i>

$sf$		Сервис фактор / <i>Service factor</i>
$R_d$	%	Динамическая эффективность / <i>Dynamic efficiency</i>
$R_s$	%	Статическая эффективность / <i>Static efficiency</i>
$R_2$	[N]	Радиальная нагрузка / <i>Permitted output radial load</i>
$A_2$	[N]	Осевая нагрузка / <i>Permitted output axial load</i>
$Z$		Число зацепления червячной передачи / <i>Worm starts</i>
$\beta$		Угол наклона линии зуба / <i>Helix angle</i>

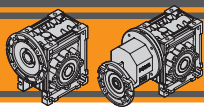

## Смазка

## Lubrication

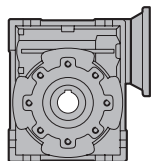

CM	Количество смазки (литры) / Oil quantity (litres)					
	B3	B8	B6	B7	V5	V6
026	0.015					
030	0.03					
040	0.07					
050	0.1					
063	0.25					
075	0.3					
090	0.85					
110	1.5					
130	4.5	3.3	3.5	3.5	4.5	3.3

На весь срок эксплуатации  
Life lubricated

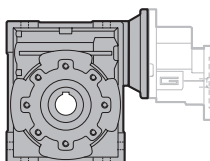

CMP	Количество смазки (литры) / Oil quantity (litres)					
	B3	B8	B6	B7	V5	V6
056/030	0.03					
056/040 - 063/040	0.07					
063/050 - 071/050	0.1					
063/063 - 071/063 - 080/063	0.25					
071/075 - 080/075 - 090/075	0.4					
071/090 - 080/090 - 090/090	0.85					
080/110 - 090/110	1.5					
080/130 - 090/130	4.5	3.3	3.5	3.5	4.5	3.3

На весь срок эксплуатации  
Life lubricated

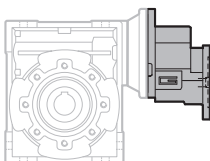

CMP				
056/030 056/040	063/040 063/050 063/063	071/050 071/063 071/075 071/090	080/063 080/075 080/090 080/110 080/130	090/075 090/090 090/110 090/130

На весь срок эксплуатации  
Life lubricated

## Монтажные позиции / Mounting positions

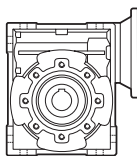

**B3**  
(Стандарт)

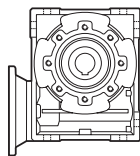

**B8**

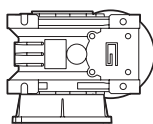

**B6**

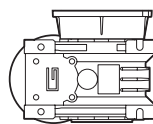

**B7**

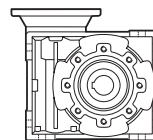

**V5**

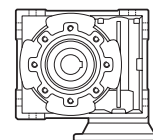

**V6**

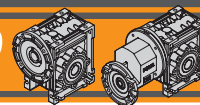

Радиальные нагрузки

Radial loads

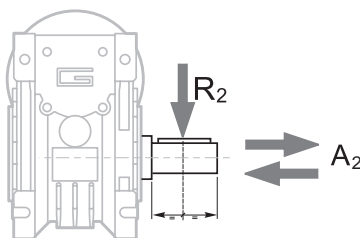

$$A_2 = R_2 \times 0.2$$

n <sub>2</sub> [min <sup>-1</sup> ]	R <sub>2</sub> [N]								
	CM026	CM030	CM040	CM050	CM063	CM075	CM090	CM110	CM130
187	400	674	1264	1770	2445	2824	3161	5058	5732
140	490	743	1392	1949	2692	3110	3481	5570	6313
93	580	851	1596	2234	3085	3564	3990	6384	7235
70	610	936	1754	2456	3392	3918	4386	7018	7953
56	610	1008	1890	2646	3654	4221	4725	7560	8567
47	610	1069	2004	2805	3874	4475	5009	8014	9083
35	610	1179	2210	3095	4273	4937	5526	8842	10021
28	610	1270	2381	3334	4603	5318	5953	9524	10794
23	610	1356	2542	3559	4915	5678	6356	10170	11526
18	610	1471	2759	3862	5334	6162	6897	11036	12507
14	610	1600	3000	4200	5800	6700	7500	12000	13600
	CMP... /030	CMP... /040	CMP... /050	CMP... /063	CMP... /075	CMP... /090	CMP... /110	CMP... /130	

CM/CMP

Если суммарная радиальная нагрузка не приходится на центр выходного вала, необходимо рассчитать её по формуле:

When the resulting radial load is not applied on the centre line of the shaft it is necessary to calculate the effective load with the following formula:

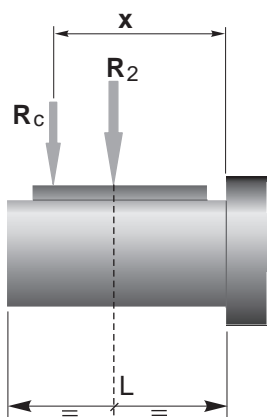

	CM	CM / CMP							
	026	030	040	050	063	075	090	110	130
a	56	65	84	101	120	131	182	176	188
b	43	50	64	76	95	101	122	136	148
R <sub>2MAX</sub>	610	1600	3000	4200	5800	6700	7500	12000	13600

$$R_c = \frac{R_2 \cdot a}{(b+x)} \leq R_{2MAX}$$

$$R \leq R_c$$

a, b = значения из таблицы  
a, b = values given in the table

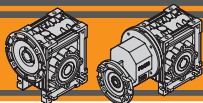

## Характеристики зубьев

## Toothing data

	Данные червячной шестерни Worm wheel data	Передаточное число / Ratio											
		5	7.5	10	15	20	25	30	40	50	60	80	100
СМ026	Z	6	4	3	2	2		1	1	1	1		
	β	34° 35'	24° 41'	19° 1'	12° 57'	10° 30'		6° 33'	5° 17'	4° 26'	3° 49'		
СМ030	Z	6	4	3	2	2	2	1	1	1	1	1	1
	β	27° 4'	24° 28'	18° 50'	12° 49'	10° 23'	8° 43'	6° 29'	5° 14'	4° 23'	3° 46'	2° 57'	2° 25'
СМ040	Z	6	4	3	2	2	2	1	1	1	1	1	1
	β	34° 19'	24° 28'	18° 50'	12° 49'	10° 23'	8° 43'	6° 29'	5° 14'	4° 23'	3° 46'	2° 57'	2° 25'
СМ050	Z	6	4	3	2	2	2	1	1	1	1	1	1
	β	33° 37'	23° 54'	18° 23'	12° 29'	10° 6'	8° 28'	6° 19'	5° 5'	4° 15'	3° 39'	2° 51'	2° 20'
СМ063	Z	6	4	3	2	2	2	1	1	1	1	1	1
	β	34° 23'	24° 31'	18° 53'	12° 50'	10° 24'	8° 44'	6° 30'	5° 14'	4° 23'	3° 47'	2° 57'	2° 25'
СМ075	Z		4	3	2	2	2	1	1	1	1	1	1
	β		26° 17'	20° 20'	13° 52'	11° 18'	9° 32'	7° 2'	5° 42'	4° 48'	4° 8'	3° 14'	2° 40'
СМ090	Z		4	3	2	2	2	1	1	1	1	1	1
	β		29° 11'	22° 43'	15° 36'	12° 50'	10° 53'	7° 56'	6° 30'	5° 29'	4° 45'	3° 45'	3° 6'
СМ110	Z		4	3	2	2	2	1	1	1	1	1	1
	β		28° 14'	21° 56'	15° 1'	14° 41'	12° 34'	7° 38'	7° 28'	6° 21'	5° 32'	4° 24'	3° 39'
СМ130	Z		4	3	2	2	2	1	1	1	1	1	1
	β		28° 43'	22° 20'	15° 19'	13° 47'	11° 54'	7° 48'	7° 00'	6° 01'	5° 16'	4° 08'	3° 27'

## КПД

## Efficiency

	n <sub>1</sub> [об/мин]	КПД Efficiency	Передаточное число / Ratio												
			5	7.5	10	15	20	25	30	40	50	60	80	100	
СМ026	2800	Rd	89	87	85	83	80		73	68	64	60			
			1400	87	84	83	78	74		66	61	57	53		
			900	84	83	80	75	71		61	57	52	48		
			Rs	72	71	68	61	56	46	41	36	34			
СМ030	2800	Rd	89	88	86	84	81	78	74	70	65	62	57	52	
			1400	86	85	84	79	75	72	67	62	58	55	48	43
			900	84	83	81	75	71	68	62	58	53	49	43	39
			Rs	72	67	63	55	50	43	39	35	31	27	23	21
СМ040	2800	Rd	90	89	87	84	83	80	77	73	69	66	60	56	
			1400	88	86	84	81	78	74	70	65	60	58	52	46
			900	86	84	82	77	74	70	66	60	57	53	46	41
			Rs	74	71	67	60	55	51	45	40	36	32	28	24
СМ050	2800	Rd	91	90	88	86	84	82	78	74	71	68	62	58	
			1400	89	87	85	82	79	76	72	67	63	60	54	49
			900	87	85	84	79	75	72	68	62	59	55	48	43
			Rs	73	70	66	59	55	51	44	39	35	32	27	23
СМ063	2800	Rd	91	90	88	86	84	83	79	76	73	70	65	60	
			1400	90	88	86	84	81	78	75	70	66	63	57	52
			900	89	86	84	81	78	75	70	65	61	58	52	47
			Rs	73	71	67	60	55	51	45	40	36	33	28	24
СМ075	2800	Rd		90	89	87	85	84	81	78	75	72	68	63	
			1400		89	87	84	83	80	77	73	69	66	60	56
			900		87	85	83	80	77	73	68	64	61	55	50
			Rs		71	68	61	57	53	46	42	38	35	29	26
СМ090	2800	Rd		91	90	88	86	85	83	80	78	75	71	67	
			1400		90	88	86	84	83	79	76	72	69	64	60
			900		88	87	84	82	80	76	72	68	65	60	55
			Rs		73	70	64	60	56	49	45	41	38	32	28
СМ110	2800	Rd		90	89	88	87	86	82	81	79	77	73	70	
			1400		89	88	86	85	84	80	79	76	73	68	64
			900		88	87	84	83	82	78	75	71	68	63	59
			Rs		72	69	63	62	59	48	46	44	41	36	32
СМ130	2800	Rd		90	89	88	87	86	82	80	79	77	72	70	
			1400		89	88	86	84	83	79	76	75	73	69	64
			900		88	87	84	82	81	77	74	73	70	64	59
			Rs		72	69	62	61	59	49	46	43	39	34	30



Теоретическое значение КПД на первом периоде эксплуатации  
Theoretical efficiency of the gearbox after the first running period

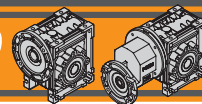

Таблицы выбора

Technical data

P <sub>1</sub> [кВт]	n <sub>2</sub> [об/мин]	M <sub>2</sub> [Нм]	sf	i				P <sub>1</sub> [кВт]	n <sub>2</sub> [об/мин]	M <sub>2</sub> [Нм]	sf	i			
-------------------------	----------------------------	------------------------	----	---	--	--	--	-------------------------	----------------------------	------------------------	----	---	--	--	--

0.18

71A6 (900 об/мин)	180	8	5.7	5	CM040		B5/B14
	120	12	4.2	7.5	CM040		B5/B14
	90	16	3.3	10	CM040		B5/B14
	60	22	2.4	15	CM040		B5/B14
	45	28	1.6	20	CM040		B5/B14
	36	33	1.3	25	CM040		B5/B14
	30	38	1.5	30	CM040		B5/B14
	23	46	1.0	40	CM040		B5/B14
	36	34	2.2	25	CM050		B5/B14
	30	39	2.5	30	CM050		B5/B14
23	47	1.8	40	CM050		B5/B14	
18	56	1.4	50	CM050		B5/B14	
15	63	1.2	60	CM050		B5/B14	
15	76	1.6	60		CMP071/050	B14	
12	90	1.2	75		CMP071/050	B14	
11	73	0.9	80	CM050		B5/B14	
10	98	1.5	90		CMP071/050	B14	
18	58	2.6	50	CM063		B5/B14	
15	66	2.1	60	CM063		B5/B14	
15	75	3.1	60		CMP071/063	B14	
12	88	2.3	75		CMP071/063	B14	
11	79	1.6	80	CM063		B5/B14	
10	101	2.8	90		CMP071/063	B14	
9	90	1.4	100	CM063		B5/B14	
7.5	121	1.9	120		CMP071/063	B14	
6.0	140	1.5	150		CMP071/063	B14	
5.0	155	1.3	180		CMP071/063	B14	
11	84	2.5	80	CM075		B5	
9	96	2.0	100	CM075		B5	
7.5	128	3.0	120		CMP071/075	B14	
6.0	149	2.3	150		CMP071/075	B14	
5.0	165	1.9	180		CMP071/075	B14	
3.8	193	1.4	240		CMP071/075	B14	
3.0	213	1.1	300		CMP071/075	B14	
5.0	179	2.9	180		CMP071/090	B14	
3.8	211	2.1	240		CMP071/090	B14	
3.0	236	1.7	300		CMP071/090	B14	

0.22

63C4 (1400 об/мин)	280	6	2.8	5	CM030		B5/B14
	187	10	2.1	7.5	CM030		B5/B14
	140	13	1.7	10	CM030		B5/B14
	93	18	1.2	15	CM030		B5/B14
	70	23	0.8	20	CM030		B5/B14
280	7	6.2	5	CM040		B5/B14	
187	10	4.5	7.5	CM040		B5/B14	
140	13	3.6	10	CM040		B5/B14	
93	18	2.5	15	CM040		B5/B14	
70	23	1.7	20	CM040		B5/B14	
56	28	1.4	25	CM040		B5/B14	
47	32	1.5	30	CM040		B5/B14	
35	39	1.1	40	CM040		B5/B14	
28	45	0.9	50	CM040		B5/B14	
23	62	0.9	60		CMP063/040	B14	
19	73	0.7	75		CMP063/040	B14	
16	83	0.9	90		CMP063/040	B14	

0.22

63C4 (1400 об/мин)	56	29	2.5	25	CM050		B5/B14
	47	32	2.7	30	CM050		B5/B14
	35	40	1.9	40	CM050		B5/B14
	28	47	1.5	50	CM050		B5/B14
	23	54	1.3	60	CM050		B5/B14
	23	63	1.6	60		CMP063/050	B14
	19	74	1.2	75		CMP063/050	B14
	18	65	0.9	80	CM050		B5/B14
	16	86	1.5	90		CMP063/050	B14
	14	74	0.8	100	CM050		B5/B14
12	104	1.1	120		CMP063/050	B14	
9.3	121	0.9	150		CMP063/050	B14	
23	57	2.2	60	CM063		B5	
23	64	2.9	60		CMP063/063	B14	
19	77	2.2	75		CMP063/063	B14	
18	68	1.7	80	CM063		B5	
16	85	2.8	90		CMP063/063	B14	
14	78	1.5	100	CM063		B5	
12	106	1.9	120		CMP063/063	B14	
9.3	126	1.5	150		CMP063/063	B14	
7.8	140	1.3	180		CMP063/063	B14	
5.8	166	0.9	240		CMP063/063	B14	
4.7	185	0.8	300		CMP063/063	B14	

0.25

63B2 (2800 об/мин)	560	4	3.4	5	CM030		B5/B14
	373	6	2.7	7.5	CM030		B5/B14
	280	7	2.2	10	CM030		B5/B14
	187	11	1.5	15	CM030		B5/B14
	140	14	1.0	20	CM030		B5/B14
	112	17	0.9	25	CM030		B5/B14
	93	19	1.0	30	CM030		B5/B14
	140	14	2.2	20	CM040		B5/B14
	112	17	1.6	25	CM040		B5/B14
	93	20	1.9	30	CM040		B5/B14
70	25	1.4	40	CM040		B5/B14	
56	29	1.1	50	CM040		B5/B14	
47	34	0.9	60	CM040		B5/B14	
47	37	1.2	60		CMP063/040	B14	
37	44	1.0	75		CMP063/040	B14	
31	50	1.1	90		CMP063/040	B14	
23	60	0.8	120		CMP063/040	B14	
70	25	2.3	40	CM050		B5/B14	
56	30	1.9	50	CM050		B5/B14	
47	35	1.5	60	CM050		B5/B14	
47	38	2.1	60		CMP063/050	B14	
37	45	1.7	75		CMP063/050	B14	
35	42	1.1	80	CM050		B5/B14	
31	51	1.9	90		CMP063/050	B14	
28	49	0.9	100	CM050		B5/B14	
23	62	1.4	120		CMP063/050	B14	
19	74	1.1	150		CMP063/050	B14	
16	83	0.9	180		CMP063/050	B14	
35	44	2.0	80	CM063		B5	
31	53	3.5	90		CMP063/063	B14	
28	51	1.6	100	CM063		B5	

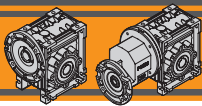

## Соединительные адаптеры для моторов IEC

## IEC Motor adapters

	IEC	N	M	P	D	i																	
						5	7.5	10	15	20	25	30	40	50	60	80	100						
CM026	56B14	50	65	80	9																		
CM030	63B5	95	115	140	11																		
	63B14	60	75	90																			
	56B5	80	100	120	9	B	B	B	B	B	B	B	B	B									
	56B14	50	65	80																			
CM040	71B5	110	130	160	14																		
	71B14	70	85	105																			
	63B5	95	115	140	11	B	B	B	B	B	B	B	B										
	63B14	60	75	90																			
	56B5	80	100	120	9	BS	BS	BS	BS	BS	BS	BS	BS	BS	B	B	B	B					
	56B14	50	65	80																			
CM050	80B5	130	165	200	19																		
	80B14	80	100	120																			
	71B5	110	130	160	14	B	B	B	B	B	B	B											
	71B14	70	85	105																			
	63B5	95	115	140	11	BS	BS	BS	BS	BS	BS	BS	BS	B	B	B	B						
	63B14	60	75	90																			
CM063	90B5	130	165	200	24																		
	90B14	95	115	140																			
	80B5	130	165	200	19	B	B	B	B	B	B	B											
	80B14	80	100	120																			
	71B5	110	130	160	14	BS	BS	BS	BS	BS	BS	BS	BS	B	B	B							
	71B14	70	85	105																			
CM075	63B5	95	115	140	11									BS	BS	BS	B	B					
	100/112B5	180	215	250	28																		
	100/112B14	110	130	160																			
	90B5	130	165	200	24		B	B	B														
	90B14	95	115	140																			
	80B5	130	165	200	19	BS	BS	BS	B	B	B	B											
CM090	80B14	80	100	120																			
	71B5	110	130	160	14									BS	BS	BS	B	B					
	100/112B5	180	215	250	28																		
	100/112B14	110	130	160																			
	90B5	130	165	200	24		B	B	B	B	B												
	90B14	95	115	140																			
CM110	80B5	130	165	200	19	BS	BS	BS	BS	BS	BS	B	B	B									
	80B14	80	100	120																			
	71B5	110	130	160	14									BS	BS	BS	B	B					
	132B5	230	265	300	38																		
	132B14	130	165	200																			
	100/112B5	180	215	250	28		B	B	B	B	B												
CM130	100/112B14	110	130	160																			
	90B5	130	165	200	24	BS	BS	BS	BS	BS	B	B	B	B									
	90B14	95	115	140																			
	80B5	130	165	200	19									BS	BS	BS	BS	B	B				
	132B5	230	265	300	38																		
	132B14	130	165	200																			

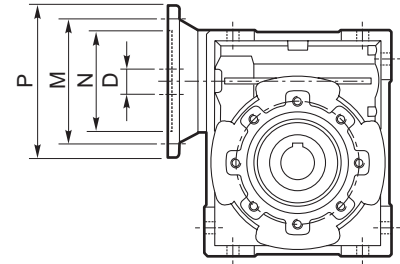

### ВНИМАНИЕ

Серым выделены возможные варианты соединений редукторов с моторами в зависимости от габарита редуктора и его передаточного числа.

*N.B. Grey areas indicate motor inputs available on each size of unit.*

**B/BS =** Необходимо применение переходной втулки

**B/BS =** Metal shaft sleeve

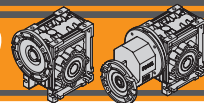

Соединительные адаптеры для моторов IEC

IEC Motor adapters

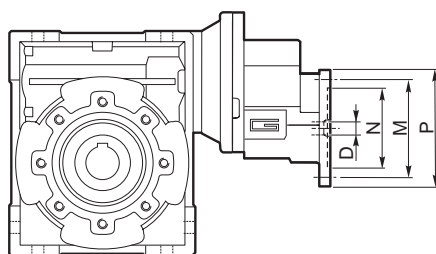

CMP	IEC	N	M	P	D	i (i <sub>1</sub> x i <sub>2</sub> )									
						60 (3x20)	75 (3x25)	90 (3x30)	120 (3x40)	150 (3x50)	180 (3x60)	240 (3x80)	300 (3x100)		
056/030	56 B14	50	65	80	9										
056/040						B	B	B	B						
063/040	63 B14	60	75	90	11										
063/050						B	B	B							
063/063						BS	BS	BS	B	B	B				
071/050	71 B14	70	85	105	14										
071/063						B	B	B							
071/075						B	B	B	B						
071/090						BS	BS	BS	B	B	B				
080/063	80 B14	80	100	120	19										
080/075															
080/090						B	B	B							
080/110						BS	BS	B	B	B	B				
080/130						BS	BS	BS	BS	B	B	B	B		
090/075	90 B14 90 B5	95 130	115 165	140 200	24										
090/090						B	B	B							
090/110						BS	BS	B	B	B	B				
090/130						BS	BS	BS	BS	B	B	B	B		

ВНИМАНИЕ

Серым выделены возможные варианты соединений редукторов с моторами в зависимости от габарита редуктора и его передаточного числа.

**B/BS = Необходимо применение переходной втулки**

N.B. Grey areas indicate motor inputs available on each size of unit.

**B/BS = Metal shaft sleeve**



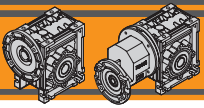

**Габаритные размеры**

**Dimensions**

**CM 040 U**

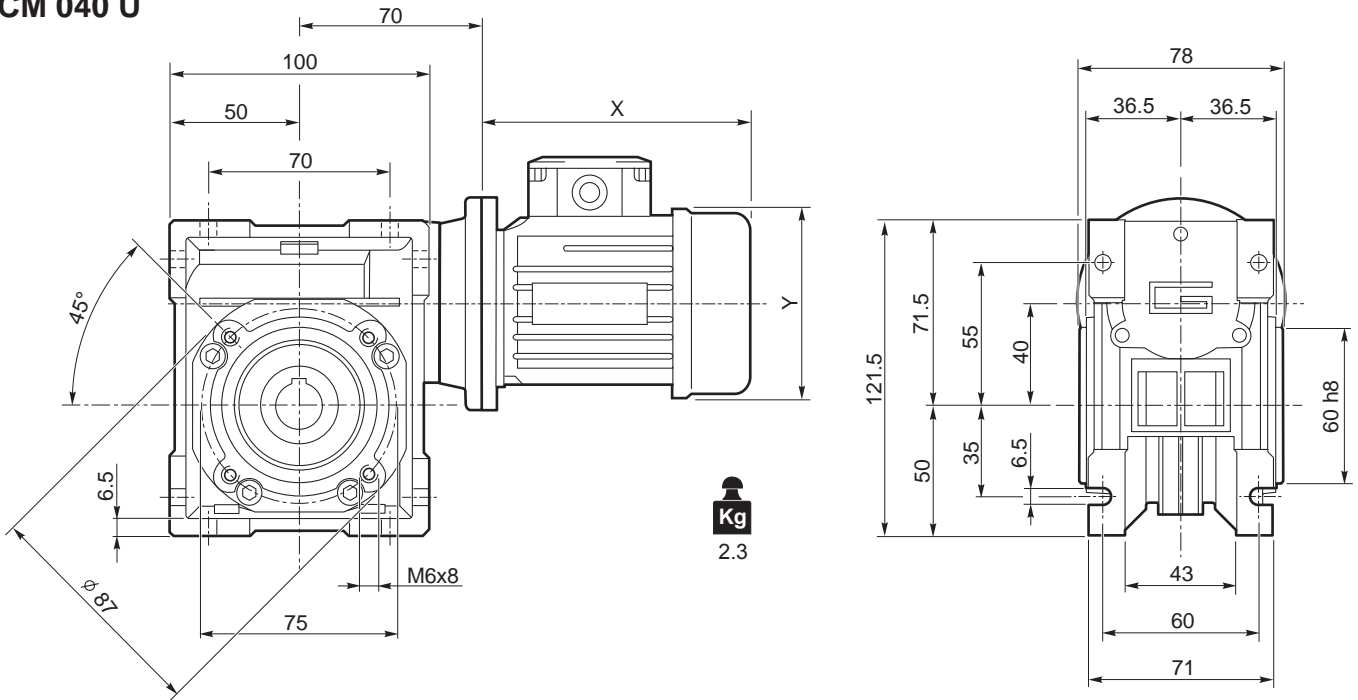

**Kg**  
2.3

**CMIS 040 ..**

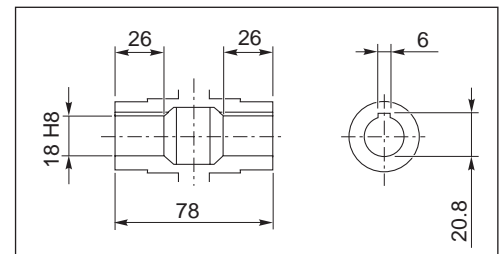
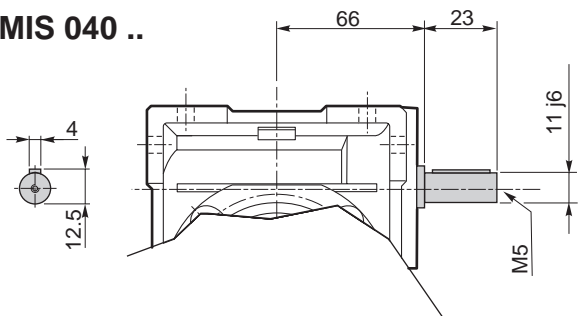

Выходной полый вал / Hollow output shaft

**CMP ..**

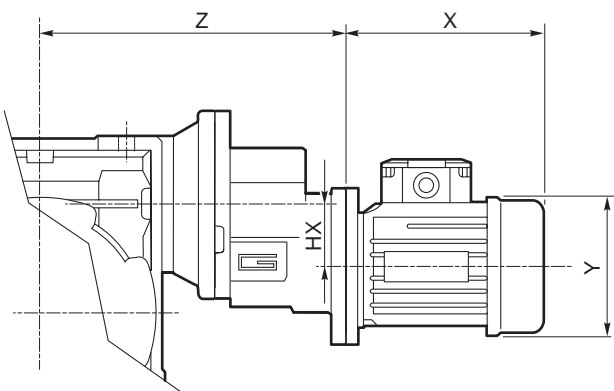

	HX	Z	<b>Kg</b>
<b>056/040</b>	30.5	139	3.2
<b>063/040</b>	30.5	142	3.3

**CM 040 .. с фланцем NEMA34 / with NEMA34 flange**

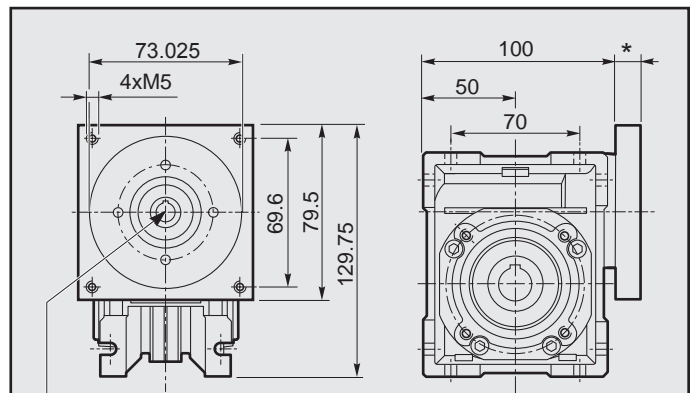

Валы соединяются посредством втулки или муфты в зависимости от диаметра вала двигателя.

Connection with sleeve or coupling depending on motorshaft's diameter.

\* Толщина фланца зависит от длины входного вала.

Flange's thickness may vary depending on motorshaft's length.

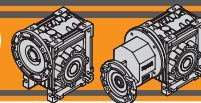

Габаритные размеры

Dimensions

