



 Acciaio inox e plastica nylon  
 Acier inox. et plastique nylon  
 Acero inox y plastico nylon

 Stainless steel and cast iron  
 Edelstahl und Grauguss  
 Нержавеющая сталь и чугун

Curva caratteristica - Performance curve - Courbe caractéristique  
 Kennlinie - Curva característica - Характеристическая кривая

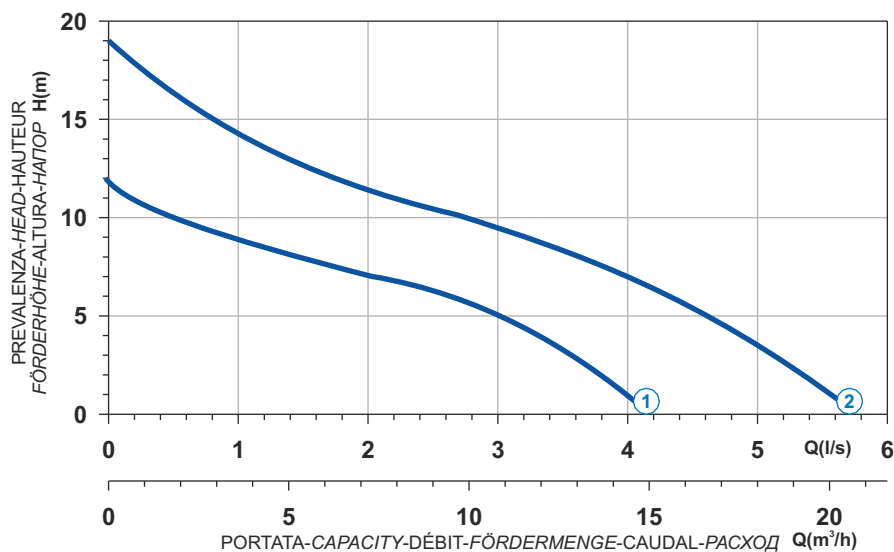

Curve N°	Code	Type	MOTOR				Free passage (mm)	Discharge	Weight (Kg)
			Power supply	R.P.M.	Rated power P2 (kW)	Rated current I (A)			
1	8001778	LDG-04T0-32	3ph 400V 50Hz	2850	0,58	1,1	10	1"1/4	7
2	8008658	LDG-07T0-32	3ph 400V 50Hz	2850	0,9	1,8	10	1"1/4	9

### Dimensioni - Dimensions - Dimensions - Abmessungen - Dimensiones - Габариты (mm)

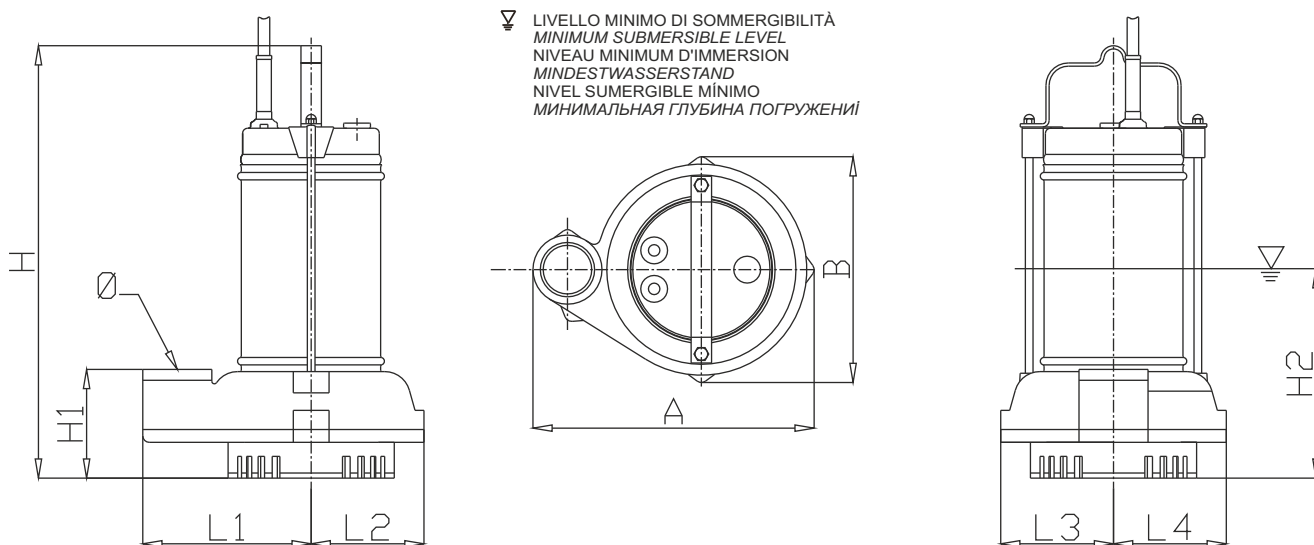

Curve	Code	Type	H	H1	H2	A	B	Ø	L1	L2	L3	L4
1	8001778	LDG-04T0-32	340	85	155	220	180	1"1/4	130	90	90	90
2	8008658	LDG-07T0-32	375	85	155	220	180	1"1/4	130	90	90	90