



 Acciaio inox e plastica nylon
 Acier inox. et plastique nylon
 Acero inox y plastico nylon

 Stainless steel and cast iron
 Edelstahl und Grauguss
 Нержавеющая сталь и чугун

Curva caratteristica - Performance curve - Courbe caractéristique
 Kennlinie - Curva característica - Характеристическая кривая

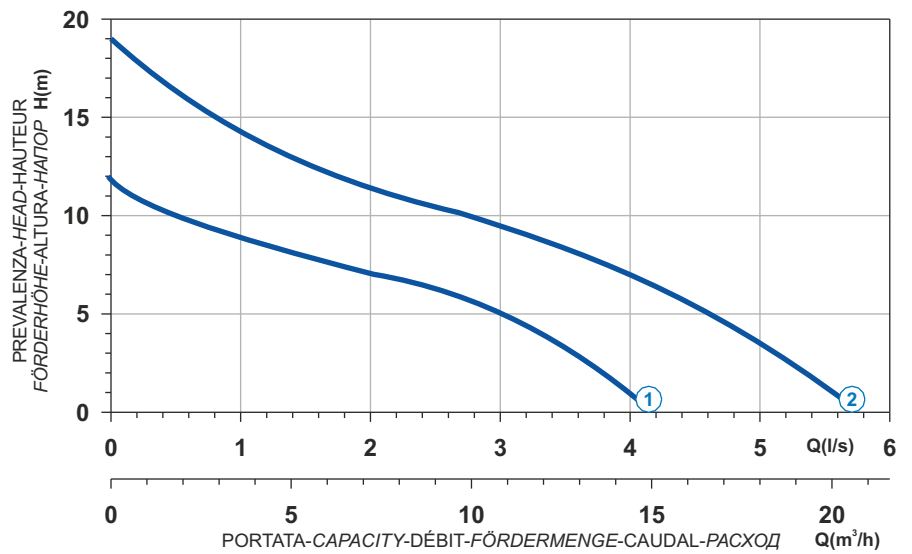

Curve N°	Code	Type	MOTOR				Free passage (mm)	Discharge	Weight (Kg)
			Power supply	R.P.M.	Rated power P2 (kW)	Rated current I (A)			
1	8001323	LDG-04MB1-32	1ph 230V 50Hz	2850	0,58	3,5	10	1"1/4	7
2	8002449	LDG-07MB1-32	1ph 230V 50Hz	2850	0,9	5,2	10	1"1/4	9

Dimensioni - Dimensions - Dimensions - Abmessungen - Dimensiones - Габариты (mm)

▽ LIVELLO MINIMO DI SOMMERSIBILITÀ
 MINIMUM SUBMERSIBLE LEVEL
 NIVEAU MINIMUM D'IMMERSION
 MINDESTWASSERSTAND
 NIVEL SUMERGIBLE MÍNIMO
 МИНИМАЛЬНАЯ ГЛУБИНА ПОГРУЖЕНИЯ

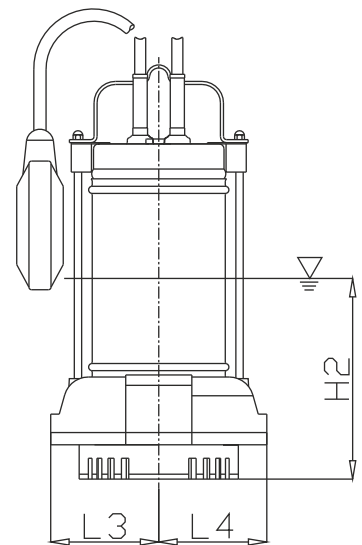
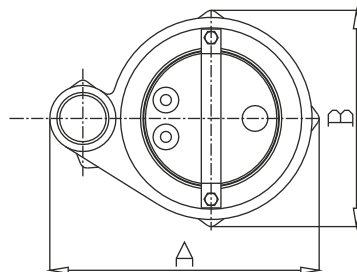
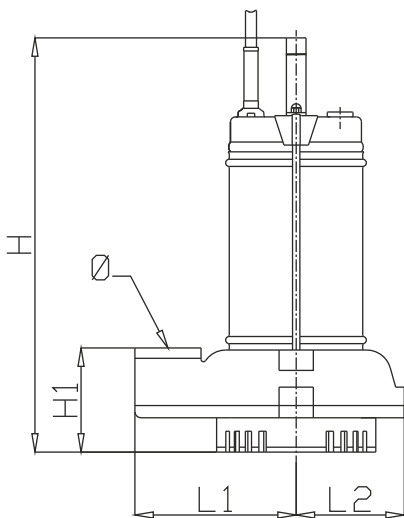

Curve	Code	Type	H	H1	H2	A	B	Ø	L1	L2	L3	L4
1	8001323	LDG-04MB1-32	340	85	155	220	180	1"1/4	130	90	90	90
2	8002449	LDG-07MB1-32	375	85	155	220	180	1"1/4	130	90	90	90